

INSPIRATION

FIND OUT YOUR INSPIRATION OF GARDEN



2



TAKE YOUR GARDENING GREENER

CONTENTS



Pruning Shears
P 5



Grape Vine Plier
P 42



Pruning Knife
P 43



Swivel Grass Shears
P 46



Hedge Shears
P 48



Lopping Shears
P 54



MINI Garden Tools
P 67



Pruning Saws
P 73



Tree Pruners
P 76



Axe, Machete
P 82



Rakes
P 84



Watering Wands
P 88



Sprinklers
P 100



Hose Repair
P 104



Oscillating
P 109

PRUNING SHEARS





AUTO-ROTATING BYPASS PRUNER



For Small Hand



For Large Hand



1. High carbon steel with non-stick TEFLON coated.
2. Fully hardened blade and hook with non-stick teflon coated.
3. Adjust lock can adjust the handles to fit large or small hands.
4. Aluminum Handle.
5. Soft grip.
6. Auto-Rotating Handle minimizes strain and fatigues especially during extended use. Soft (TPR) grip.
7. Large Protection Handle protects fingers from hornng branches while pruning.



Left Hand



Right Hand



PC-P01.3102AR
Auto-Rotating Bypass Pruner



For both Right and Left hand versions



Sap Groove



PC-P01.3102A-1
Auto-Rotating Bypass Pruner

PC-P01.3102B
Auto-Rotating Anvil Pruner



PC-P01.3102BR-1
Auto-Rotating Anvil Pruner

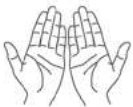

For both Right and Left hand versions



Item No.	Full Length	Cutting Capacity	Packing	Box / CTN	N.W. / G.W.	CUFT
PC-P01.3102AR	215 mm (8 1/2")	20 mm	Tied on Card	6 / 48	15.5 / 16.5	2.3
PC-P01.3102A-1	215 mm (8 1/2")	20 mm	Blister Card	10 / 60	19 / 20	1.9
PC-P01.3102B	215 mm (8 1/2")	20 mm	Tied on Card	6 / 48	14.5 / 15.5	2.3
PC-P01.3102BR-1	215 mm (8 1/2")	20 mm	Blister Card	10 / 60	15 / 16	1.7



For both Right and
Left hand versions



PC-P01.3140R

Super Auto-Rotating Ratchet Pruner



Ratchet

PC-P01.3140-1

Super Auto-Rotating Ratchet Pruner

Item No.	Full Length	Cutting Capacity	Packing	Box / CTN	N.W. / G.W.	CUFT
PC-P01.3140R	215 mm (8 1/2")	24 mm	Tied on Card	6 / 48	15.5 / 16.5	2.3
PC-P01.3140-1	215 mm (8 1/2")	24 mm	Blister Card	10 / 60	15.5 / 16.5	2.2
PC-P01.3142	200 mm (8")	24 mm	Sliding Card	10 / 60	15.0 / 16.0	1.45
PC-B01.8A6638	200 mm (8")	20 mm	Sliding Card	10 / 60	13.7 / 15.3	1.68



PC-P01.3142

Ratchet Pruning Shears



Ratchet



PC-B01.8A6638

Ratchet Pruning Shears



Ratchet



PC-P01.3152 PC-P01.3152-1
Heavy Duty Bypass Pruner



PC-P01.3152C PC-P01.3152C-1
Heavy Duty Anvil Pruner



Sap Groove



Delrin Anvil

Item No.	Full Length	Cutting Capacity	Packing	Box / CTN	N.W. / G.W.	CUFT
PC-P01.3152	205 mm (8")	20 mm	Blister Card	10 / 60	13 / 14	1.2
PC-P01.3152-1	180 mm (7")	15 mm	Blister Card	10 / 60	12 / 13	1.1
PC-P01.3152C	190 mm (7 1/2")	18 mm	Blister Card	10 / 60	13 / 14	1.2
PC-P01.3152C-1	170 mm (6 3/4")	15 mm	Blister Card	10 / 60	11 / 12	1.2



PC-P01.3152-2L PC-P01.3152-2
Heavy Duty Trimming Pruner

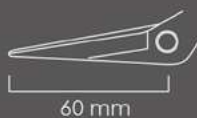
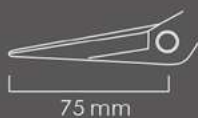

PC-P01.3165
Premium Bypass Pruner



Item No.	Full Length	Cutting Capacity	Packing	Box / CTN	N.W. / G.W.	CUFT
PC-P01.3152-2L	200 mm (7 3/4")	6 mm	Blister Card	10 / 60	13 / 14	1.2
PC-P01.3152-2	178 mm (7")	6 mm	Blister Card	10 / 60	12 / 13	1.1
PC-P01.3165	205 mm (8")	20 mm	Blister Card	10 / 60	16.5 / 17.5	1.25



ROTATING BYPASS FORGED PRUNER



PC-P01.3103A



For Small Hand



For Large Hand



Left Hand



Right Hand

PC-P01.3103A-1

Aluminum Forged Bypass Pruner



PC-P01.3103A-5

Aluminum Forged Bypass Pruner



PC-P01.3103A-4

Aluminum Forged Bypass Pruner



PC-P01.3103A-2

Aluminum Forged Bypass Pruner



Item No.	Full Length	Cutting Capacity	Packing	Box / CTN	N.W. / G.W.	CUFT
PC-P01.3103A	215 mm (8 1/2")	20 mm	Blister Card	10 / 60	19 / 20	1.65
PC-P01.3103A-1	215 mm (8 1/2")	20 mm	Blister Card	10 / 60	17.5 / 19	1.65
PC-P01.3103A-5	215 mm (8 1/2")	20 mm	Blister Card	10 / 60	17.5 / 19	1.65
PC-P01.3103A-4	215 mm (8 1/2")	20 mm	Blister Card	10 / 60	17.5 / 19	1.65
PC-P01.3103A-2	205 mm (8")	18 mm	Blister Card	10 / 60	16.5 / 17.5	1.65

Item No.	Full Length	Cutting Capacity	Packing	Box / CTN	N.W. / G.W.	CUFT
PC-P01.3169A	230 mm (9")	20 mm	Blister Card	10 / 60	18 / 19	1.6
PC-P01.3169A-1	210 mm (8 1/4")	18 mm	Blister Card	10 / 60	18 / 19	1.4
PC-P01.3169	230 mm (9")	20 mm	Blister Card	10 / 60	18 / 19	1.6
PC-P01.3169-1	210 mm (8 1/4")	18 mm	Blister Card	10 / 60	17 / 18	1.4



PC-P01.3169A PC-P01.3169A-1
Aluminum Forged Bypass Pruner



PC-P01.3169 PC-P01.3169-1
Professional Bypass Pruner



PRUNING SHEARS



PC-P01.3174

PC-P01.3174-1

Remove the horn from the stem easily and safely



For Thick



For Thin

Item No.	Full Length	Cutting Capacity	Packing	Box / CTN	N.W. / G.W.	CUFT
PC-P01.3174	205 mm (8")	15 mm	Blister Card	10 / 60	10 / 11	1.4
PC-P01.3174-1	205 mm (8")	8 mm	Blister Card	10 / 60	10 / 11	1.4

Item No.	Full Length	Cutting Capacity	Packing	Box / CTN	N.W. / G.W.	CUFT
PC-P01.3150L	170 mm (6 3/4")	12 mm	Blister Card	10 / 60	15 / 16	1.3
PC-P01.3150S	153 mm (6")	6 mm	Blister Card	10 / 60	12.5 / 13.5	0.9
PC-P01.3150L-1	170 mm (6 3/4")	8 mm	Blister Card	10 / 60	15 / 16	1.3
PC-P01.3150S-1	153 mm (6")	6 mm	Blister Card	10 / 60	12.5 / 13.5	0.9



PC-P01.3150L
Bypass Pruner
 Stainless Steel Blade



PC-P01.3150S
Bypass Pruner
 Stainless Steel Blade



PC-P01.3150L-1
Trimmer Pruner
 Stainless Steel Blade



PC-P01.3150S-1
Trimmer Pruner
 Stainless Steel Blade

PC-P01.3171
Mini Pruning Shears



PC-P01.3171-1
Mini Pruning Shears



PC-P01.3171A
Pruning Shears



PC-P01.3171B
Pruning Shears



Item No.	Full Length	Cutting Capacity	Packing	Box / CTN	N.W. / G.W.	CUFT
PC-P01.3171	165 mm (6 1/2")	10 mm	Blister Card	10 / 100	11 / 12	1.7
PC-P01.3171-1	165 mm (6 1/2")	6 mm	Blister Card	10 / 100	11 / 12	1.7
PC-P01.3171A	195 mm (7 3/4")	18 mm	Blister Card	10 / 60	13 / 14	1.4
PC-P01.3171B	205 mm (8")	18 mm	Blister Card	10 / 60	13 / 14	1.4



ADJUSTABLE HANDLE PRUNER



For Small Hand



For Large Hand

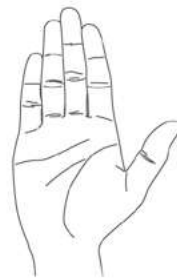

Remove the horn from the stem easily and safely



Squeeze stem for absorbing the water in vase more efficiently



PC-P01.3168A-1
Adjustable Handle
Anvil Pruner



PC-P01.3168B-1
Adjustable Handle
Bypass Pruner



PC-P01.3168A
Anvil pruning Shears



PC-P01.3168B
Bypass Pruning Shears

Item No.	Full Length	Cutting Capacity	Packing	Box / CTN	N.W. / G.W.	CUFT
PC-P01.3168A-1	205 mm (8")	10 or 18 mm	Blister Card	10 / 60	18 / 19	1.6
PC-P01.3168B-1	205 mm (8")	10 or 18 mm	Blister Card	12 / 60	18 / 19	1.6
PC-P01.3168A	205 mm (8")	18 mm	Blister Card	10 / 60	18 / 19	1.6
PC-P01.3168B	205 mm (8")	18 mm	Blister Card	10 / 60	18 / 19	1.6

PC-P01.3177A
Anvil Pruner



PC-P01.3177B
Bypass Pruner



PC-P01.3158A
Ergonomic Anvil Pruner



PC-P01.3158B
Ergonomic Bypass Pruner



Item No.	Full Length	Cutting Capacity	Packing	Box / CTN	N.W. / G.W.	CUFT
PC-P01.3177A	205mm (8")	15 mm	Blister Card	10 / 60	12 / 13	1.5
PC-P01.3177B	205 mm (8")	15 mm	Blister Card	10 / 60	12.5 / 13.5	1.5
PC-P01.3158A	205 mm (8")	18 mm	Blister Card	10 / 60	15 / 16	2.0
PC-P01.3158B	205 mm (8")	18 mm	Blister Card	10 / 60	15 / 16	2.0



PC-P01.3173A
Anvil Pruner



PC-P01.3173B
Bypass Pruner



PC-P09.8B01
Bypass Pruner



PC-P09.8B02
Bypass Pruner

Item No.	Full Length	Cutting Capacity	Packing	Box / CTN	N.W / G.W	CUFT
PC-P01.3173A	205 mm (8")	15 mm	Blister Card	10 / 60	14 / 15	1.4
PC-P01.3173B	205 mm (8")	15 mm	Blister Card	10 / 60	14 / 15	1.4
PC-P09.8B01	205 mm (8")	15 mm	Blister Card	10 / 60	13.2 / 14.7	1.75
PC-P09.8B02	205 mm (8")	15 mm	Blister Card	10 / 60	13.2 / 14.7	1.75
PC-P09.871	205 mm (8")	15 mm	Blister Card	10 / 60	14.4 / 16.1	1.95
PC-P09.872	205 mm (8")	15 mm	Blister Card	10 / 60	15.1 / 16.6	1.95
PC-P09.873	205 mm (8")	-	Blister Card	10 / 60	13.8 / 15.3	1.95



PC-P09.871
Premium Anvil Pruner



PC-P09.872
Premium Bypass Pruner



PC-P09.873
Premium Straight
Blade Pruner

PC-P02.820
215mm Bypass Pruning Shear



PC-P02.820B
210mm Anvil Pruning Shear



PC-P02.819-1
210mm Bypass Pruning Shear



PC-P02.7025CN
170mm Bypass Pruning Shear



PC-P02.7025ACN
170mm Trimmer Pruning Shear



Item No.	Full Length	Cutting Capacity	Packing	Box / CTN	N.W. / G.W.	CUFT
PC-P02.820	215 mm (8 1/2")	16 mm	Sliding Card	10 / 60	15.5 / 17.0	1.65
PC-P02.820B	210 mm (8 1/4")	14 mm	Sliding Card	10 / 60	15.5 / 17.0	1.65
PC-P02.819-1	210 mm (8 1/4")	18 mm	Sliding Card	10 / 60	13.5 / 15.0	1.55
PC-P02.7025CN	170 mm (6 3/4")	18 mm	Sliding Card	10 / 60	8.0 / 9.5	1.20
PC-P02.7025ACN	170 mm (6 3/4")	14 mm	Sliding Card	10 / 60	8.0 / 9.5	1.20

Item No.	Full Length	Cutting Capacity	Packing	Box / CTN	N.W. / G.W.	CUFT
PC-P02.736	215 mm (8 1/2")	18 mm	Sliding Card	10 / 60	14.0 / 15.5	1.56
PC-P02.739C	205 mm (8")	14 mm	Sliding Card	10 / 60	13.0 / 14.5	1.50
PC-P02.736B	205 mm (8")	16 mm	Sliding Card	10 / 60	18.0 / 19.5	1.60
PC-P02.739CB	190 mm (7 1/2")	12 mm	Sliding Card	10 / 60	13.0 / 14.5	1.30



PC-P02.736
215mm Bypass
Pruning Shears



PC-P02.739C
205mm Bypass
Pruning Shears



PC-P02.736B
205mm Anvil
Pruning Shear



PC-P02.739CB
190mm Anvil
Pruning Shear



PC-P02.739D
215mm Bypass
Pruning Shears



PC-P02.739A
215mm Bypass
Pruning Shears



PC-P02.739E
215mm Bypass
Pruning Shears

Item No.	Full Length	Cutting Capacity	Packing	Box / CTN	N.W / G.W	CUFT
PC-P02.739D	215 mm (8 1/2")	16 mm	Sliding Card	10 / 60	16.8 / 18.3	1.60
PC-P02.739A	215 mm (8 1/2")	16 mm	Sliding Card	10 / 60	20.0 / 21.5	1.60
PC-P02.739E	215 mm (8 1/2")	16 mm	Sliding Card	10 / 60	20.3 / 21.8	1.60
PC-P02.739L	228 mm (9")	16 mm	Sliding Card	10 / 60	17.5 / 19.0	1.50
PC-P02.739A-1	215 mm (8 1/2")	16 mm	Sliding Card	10 / 60	18.0 / 19.5	1.60
PC-P02.729C	205 mm (8")	12 mm	Sliding Card	10 / 60	14.5 / 16.0	1.30
PC-P02.729	215 mm (8 1/2")	14 mm	Sliding Card	10 / 60	16.0 / 17.5	1.38
PC-P02.729A	215 mm (8 1/2")	14 mm	Sliding Card	10 / 60	16.5 / 18.0	1.43



PC-P02.739L
228mm Bypass
Pruning Shears



PC-P02.739A-1
215mm Bypass
Pruning Shears



PC-P02.729C
205mm Bypass
Pruning Shears



PC-P02.729
215mm Bypass
Pruning Shears



PC-P02.729A
215mm Bypass
Pruning Shears



PC-P02.739L-1
228mm Bypass Pruning Shear
with "Cut & Hold" Feature for Flower



PC-P02.739B
215mm Anvil Pruning Shears

PC-P02.747
215mm Floral Pruning Shears



PC-P02.7007
215mm Bypass Pruning Shears



PC-P02.615
220mm Bypass Pruning Shear



Item No.	Full Length	Cutting Capacity	Packing	Box / CTN	N.W. / G.W.	CUFT
PC-P02.739L-1	228 mm (9")	14 mm	Sliding Card	10 / 60	17.5 / 19.0	1.50
PC-P02.739B	215 mm (8 1/2")	14 mm	Sliding Card	10 / 60	18.0 / 19.5	1.60
PC-P02.747	215 mm (8 1/2")	16 mm	Sliding Card	10 / 60	16.5 / 18.0	1.70
PC-P02.7007	215 mm (8 1/2")	20 mm	Sliding Card	10 / 60	16.0 / 17.5	1.70
PC-P02.615	220 mm (8 3/4")	16 mm	Sliding Card	10 / 60	20.0 / 21.5	1.20

Item No.	Full Length	Cutting Capacity	Packing	Box / CTN	N.W. / G.W.	CUFT
PC-P02.633	210 mm (8 1/4")	18 mm	Sliding Card	10 / 60	16.0 / 17.5	1.66
PC-P02.730B	215 mm (8 1/2")	-	Sliding Card	10 / 60	17.5 / 19.0	1.70
PC-P02.733EL	205 mm (8")	16 mm	Sliding Card	10 / 60	20.0 / 21.5	1.50
PC-P02.733	165 mm (6 1/2")	15 mm	Sliding Card	10 / 60	12.5 / 14.0	1.20



PC-P02.633
210mm Anvil
Pruning Shear



PC-P02.730B
215mm Drop
Forged Anvil
Pruning Shear



PC-P02.733EL
205mm Anvil
Pruning Shear



PC-P02.733
165mm Anvil
Pruning Shear



PC-P01.3161
**2-in-1 Telescopic Handle
 Bypass Pruner + Mini Lopper**



PC-P01.3161A
**2-in-1 Telescopic Handle Ratchet
 Pruner + Mini Ratchet Lopper**

Item No.	Full Length	Cutting Capacity	Packing	Box/CTN	N.W./G.W.	CUFT	CBM
PC-P01.3161	223 - 285mm	18mm	Sliding Card	6 / 36	12.5 / 13.5	1.70	0.048
PC-P01.3161A	240 - 310mm	20mm	Sliding Card	6 / 36	14.0 / 15.0	1.30	0.037



PC-P01.3180T
210mm Professional Bypass Pruner, Adj. Handle & Blade Opening Size



PC-P02.4240C
220mm Lightweight Robust Bypass Pruning Shears



PC-P02.7013
215mm Drop Forged Bypass Pruning Shears



PC-P02.7012
210mm Drop Forged Anvil Pruning Shears

Item No.	Full Length	Cutting Capacity	Packing	Box/CTN	N.W./G.W.	CUFT	CBM
PC-P01.3180T	210mm (8 1/4")	20mm	Sliding Card	10 / 60	19.0 / 20.0	1.70	0.048
PC-P02.4240C	220mm (8 3/4")	16mm	Sliding Card	10 / 60	16.0 / 17.5	1.60	0.045
PC-P02.7013	215mm (8 1/2")	18mm	Sliding Card	10 / 60	16.2 / 17.7	1.25	0.035
PC-P02.7012	210mm (8 1/4")	18mm	Sliding Card	10 / 60	14.4 / 15.9	1.25	0.035



PC-P02.769
200mm Bypass Pruning Shears



PC-P09.8B2507-1
202mm Bypass Pruning Shears



PC-P09.8S2507-1
204mm Trimming Pruning Shears



PC-P10.311
185mm Bypass Pruning Shears



PC-P10.302A
180mm Anvil Pruning Shears, Hand Size Adj.



PC-P10.302B
180mm Bypass Pruning Shears, Hand Size Adj.

Item No.	Full Length	Cutting Capacity	Packing	Box/CTN	N.W./G.W.	CUFT	CBM
PC-P02.769	200mm (8")	18mm	Sliding Card	10 / 60	14.0 / 15.5	1.50	0.042
PC-P09.8B2507-1	200mm (8")		Sliding Card	10 / 60	10.6 / 12.1	1.15	0.033
PC-P09.8S2507-1	204mm		Sliding Card	10 / 60	10.9 / 12.4	1.15	0.033
PC-P10.311	185mm (7 1/4")	15mm	Sliding Card	10 / 60	10.8 / 12.0	1.50	0.042
PC-P10.302A	180mm (7")	18mm	Sliding Card	10 / 60	18.0 / 19.0	1.50	0.042
PC-P10.302B	180mm (7")	18mm	Sliding Card	10 / 60	18.0 / 19.0	1.50	0.042



PC-P01.3148-1
205mm Ratchet Pruning Shears with Oil Sponge



PC-P01.3130-1A
205mm Ratchet Pruner with Fingerguard Protection



PC-P01.3130-3
205mm Ratchet Pruner with Oil Spong & Fingerguard



PC-P09.8A07
215mm Gear Pruner with Fingerguard



PC-P09.8A07A
215mm Gear Pruner

Item No.	Full Length	Cutting Capacity	Packing	Box/CTN	N.W./G.W.	CUFT	CBM
PC-P01.3148-1	205mm (8")	24mm	Sliding Card	10 / 60	16.0 / 17.0	1.40	0.040
PC-P01.3130-1A	205mm (8")	20mm	Sliding Card	10 / 60	18.0 / 19.0	1.60	0.045
PC-P01.3130-3	205mm (8")	20mm	Sliding Card	10 / 60	16.0 / 17.0	1.60	0.045
PC-P09.8A07	215mm (8 1/2")		Sliding Card	10 / 60	16.9 / 18.4	1.65	0.047
PC-P09.8A07A	215mm (8 1/2")		Sliding Card	10 / 60	15.4 / 16.9	1.20	0.034

PC-P02.7025AC-1
**170mm Drop Forged
 Trimming Pruner**



PC-P02.7025B-1
**205mm Drop Forged
 Anvil Pruning Shears**



PC-P02.7022CN
**195mm Drop Forged
 Bypass Pruning Shears**



PC-P02.7022N
**215mm Drop Forged
 Bypass Pruning Shears**



PC-P01.3103A-6
**210mm Drop Forged
 Anvil Pruner**



Item No.	Full Length	Cutting Capacity	Packing	Box/CTN	N.W./G.W.	CUFT	CBM
PC-P02.7025AC-1	170mm (6 3/4")	14mm	Sliding Card	10 / 60	13.5 / 15.0	1.65	0.047
PC-P02.7025B-1	205mm (8")	20mm	Sliding Card	10 / 60	13.5 / 15.0	1.65	0.047
PC-P02.7022CN	195mm (7 3/4")	18mm	Sliding Card	10 / 60	18.0 / 19.5	1.50	0.042
PC-P02.7022N	215mm (8 1/2")	20mm	Sliding Card	10 / 60	20.0 / 21.5	1.90	0.054
PC-P01.3103A-6	210mm (8 1/4")	20mm	Sliding Card	10 / 60	20.5 / 21.5	1.90	0.054

PC-B01.8A6436
213mm Anvil Pruning Shears



PC-B01.8B6436
211mm Bypass Pruning Shears



PC-P09.8A0826
200mm Anvil Pruner, Leverage Type



PC-P09.8B0826
200mm Bypass Pruner, Leverage Type



Item No.	Full Length	Cutting Capacity	Packing	Box/CTN	N.W./G.W.	CUFT	CBM
PC-B01.8A6436	213mm (8")	20mm	Sliding Card	10 / 60	17.0 / 18.0	1.70	0.048
PC-B01.8B6436	205mm (8")	20mm	Sliding Card	10 / 60	17.0 / 18.0	1.70	0.048
PC-P09.8A0826	200mm (8")	20mm	Sliding Card	10 / 60	14.8 / 16.3	1.80	0.051
PC-P09.8B0826	200mm (8")	20mm	Sliding Card	10 / 60	14.8 / 16.3	1.80	0.051



PC-P10.303B
190mm Bypass
Cutting Gardening
Tools



PC-P10.304
200mm Professional
High Quality Bypass
Pruning Shears



PC-P10.305
210mm SK5 High
Carbon Steel Bypass
Pruning Shears

Item No.	Full Length	Cutting Capacity	Packing	Box/CTN	N.W./G.W.	CUFT	CBM
PC-P10.303B	190mm (7 1/2")	18mm	Sliding Card	10 / 60	12.8 / 13.8	1.30	0.037
PC-P10.304	205mm (8")	20mm	Sliding Card	10 / 60	18.5 / 19.0	1.50	0.042
PC-P10.305	205mm (8")	20mm	Sliding Card	10 / 60	18.5 / 19.0	1.50	0.042



PC-P02.815B / PC-P02.815

195mm Hand Size Adj. Anvil Pruning Shears/ 205mm Hand Size Adj. Bypass Pruning Shears



PC-P02.862B / PC-P02.862

GEAR Design Anvil Pruning Shears / GEAR Design Bypass Pruning Shears

Item No.	Full Length	Cutting Capacity	Packing	Box/CTN	N.W./G.W.	CUFT	CBM
PC-P02.815B	195mm (7 3/4")	16 - 20mm	Sliding Card	10 / 60	16.7 / 18.2	1.50	0.042
PC-P02.815	205mm (8")	14 - 18mm	Sliding Card	10 / 60	16.7 / 18.2	1.50	0.042
PC-P02.862B	205mm (8")	18mm	Sliding Card	10 / 60	12.3 / 13.8	1.45	0.041
PC-P02.862	205mm (8")	18mm	Sliding Card	10 / 60	14.7 / 16.2	1.55	0.044



PC-P09.8A1230 / PC-P09.8B1230
210mm Anvil Pruner / 215mm Bypass Pruner



PC-P09.8A02A / PCP09.8B02A / PC-P09.8S02A
200mm Anvil Pruning Shears/ 205mm Bypass Pruning Shears / 218mm Trimming Pruning Shears

Item No.	Full Length	Packing	Box/CTN	N.W./G.W.	CUFT	CBM
PC-P09.8A1230	210mm (8 1/4")	Sliding Card	10 / 60	13.8 / 15.3	1.60	0.045
PC-P09.8B1230	215mm (8 1/2")	Sliding Card	10 / 60	13.8 / 15.3	1.60	0.045
PC-P09.8A02A	200mm (8")	Sliding Card	10 / 60	13.4 / 15.0	1.66	0.047
PC-P09.8B02A	205mm (8")	Sliding Card	10 / 60	13.4 / 15.0	1.66	0.047
PC-P09.8S02A	218mm	Sliding Card	10 / 60	13.4 / 15.0	1.66	0.047



FLORAL PRUNING SHEAR



Provided With Ring

Item No.	Full Length	Cutting Capacity	Packing	Box / CTN	N.W. / G.W.	CUFT
PC-P02.207AS	150 mm (6")	10 mm	Sliding Card	10 / 60	6.5 / 7.0	1.4
PC-P02.207S	150 mm (6")	14 mm	Sliding Card	10 / 60	6.5 / 7.0	1.4
PC-P02.207BS	140 mm (5 1/2")	8 mm	Sliding Card	10 / 60	6.5 / 7.0	1.4



PC-P02.207AS
150mm Floral
Pruning Shear



PC-P02.207S
150mm Bypass
Pruning Shear



PC-P02.207BS
140mm Floral
Pruning Shear



PC-P02.204A
175mm Trimmer
Pruning Shear



PC-P02.204
150mm Bypass
Pruning Shear



PC-P02.204B
140mm Trimmer
Pruning Shear



PC-P02.315PS
155mm Mini
Bypass Pruning Shear



PC-P02.315PAS
155mm Mini Trimmer
Pruning Shear

Item No.	Full Length	Cutting Capacity	Packing	Box / CTN	N.W. / G.W.	CUFT
PC-P02.204A	170 mm (6 3/4")	10 mm	Sliding Card	10 / 100	10.0 / 11.0	0.8
PC-P02.204	150 mm (6")	12 mm	Sliding Card	10 / 100	10.0 / 11.0	0.8
PC-P02.204B	140 mm (5 1/2")	10 mm	Sliding Card	10 / 100	10.0 / 11.0	0.8
PC-P02.315PS	155 mm (6")	10 mm	Sliding Card	10 / 100	16.0 / 17.0	1.1
PC-P02.315PAS	155 mm (6")	6 mm	Sliding Card	10 / 100	15.0 / 16.0	1.1



PC-P02.803S-1
185mm Harvester
- Curved Blade

PC-P02.803BS-1
165mm Harvester
- Curved Blade

PC-P02.803S
190mm Harvester
- Straight Blade

PC-P02.803BS
165mm Harvester
- Straight Blade

Item No.	Full Length	Cutting Capacity	Packing	Box / CTN	N.W. / G.W.	CUFT
PC-P02.803S-1	185 mm (7 1/4")	10 mm	Sliding Card	10 / 100	16.0 / 17.5	1.44
PC-P02.803BS-1	165 mm (6 1/2")	10 mm	Sliding Card	100 pcs	13.6 / 15.1	1.10
PC-P02.803S	190 mm (7 1/2")	10 mm	Sliding Card	100 pcs	16.0 / 17.5	1.44
PC-P02.803BS	165 mm (6 1/2")	10 mm	Sliding Card	100 pcs	13.6 / 15.1	1.10

Item No.	Full Length	Cutting Capacity	Packing	Box / CTN	N.W. / G.W.	CUFT
PC-P02.804C	180 mm (7")	10 mm	Sliding Card	100 pcs	14.0 / 15.5	1.10
PC-P02.803	190 mm (7 1/2")	10 mm	Sliding Card	10 / 100	16.0 / 17.5	1.10
PC-P02.803B	165 mm (6 1/2")	10 mm	Sliding Card	100 pcs	13.5 / 15.0	1.10
PC-P02.803A	185 mm (7 1/4")	10 mm	Sliding Card	10 / 100	16.0 / 17.5	1.44
PC-P02.803B-1	165 mm (6 1/2")	10 mm	Sliding Card	100 pcs	13.5 / 15.0	1.10



PC-P02.804C
180mm Bypass
Pruning Shears
/ Harvester

PC-P02.803
190mm Floral
Shear -
Straight Blade

PC-P02.803B
165mm Harvester
- Straight Blade

PC-P02.803A
185mm Floral
Shear -
Curved Blade

PC-P02.803B-1
165mm Harvester
- Curved Blade

Item No.	Packing	Box/CTN	N.W./G.W.	CUFT	CBM
PC-P09.8S4316	Sliding Card	12 / 72	12.6 / 14.0	1.87	0.053
PC-P09.8S5831	Sliding Card	10 / 120	12.5 / 14.0	1.90	0.054
PC-B01.8S6335	Sliding Card	10 / 60	5.2 / 6.6	1.16	0.033

PC-P09.8S4316
**220mm Kitchen Scissor
 with Sheath, Tungsten
 Carbide Sharpener on
 Sheath**



PC-P09.8S5831
**178mm Multi-Function
 Kitchen Scissor**



PC-B01.8S6335
**170mm Stainless
 Steel Flower Scissor**

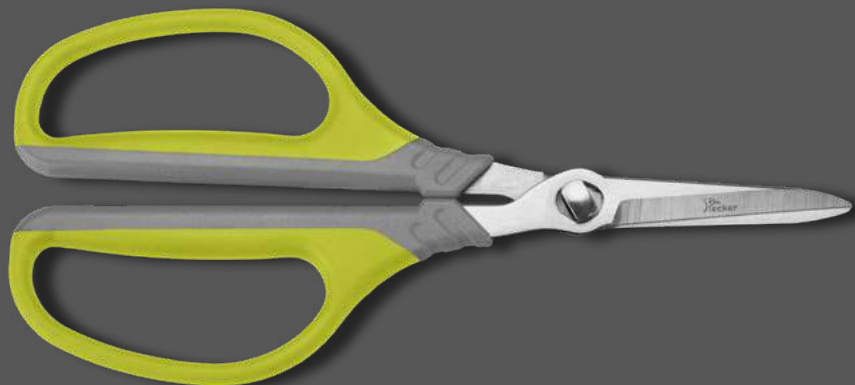



GRAPE VINE PLIER



PC-G14.J99
Grape Vine Plier

Open the lid and put the tape into the machine



Pull the tape from bottom

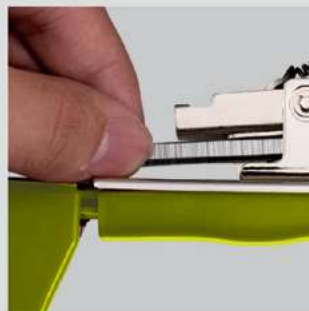

Put the staples



Press and the tape out

Item No.	Full Length	Cutting Capacity	Packing	Box / CTN	N.W. / G.W.	CUFT
PC-G14.J99	32 mm	5 mm	Color Box	10pcs	7.0 / 8.0	0.8

PC-P02.012A
180mm Pruning Knife



PC-P02.011A-1
195mm Pruning Knife



PC-P02.011AC-1
185mm Pruning Knife



Slice



Open

Item No.	Full Length	Cutting Capacity	Packing	Box / CTN	N.W. / G.W.	CUFT
PC-P02.012A	180mm (7")	-	Sliding Card	20 / 100	10.5 / 12.0	1.3
PC-P02.011A-1	195mm (7 3/4")	-	Sliding Card	20 / 100	7.6 / 8.6	1.1
PC-P02.011AC-1	185 mm (7 1/4")	-	Sliding Card	20 / 100	6.0 / 7.0	1.1
PC-P02.007-1	153 mm (6 1/2")	-	Sliding Card	10 / 100	5 / 6	1.8



PC-P02.007-1
153mm Multi-Sharpener



Sharpen the blade



Oil the blade



PC-P09.847A
**318mm Hori Hori Shovel Knife with
 Nylon Holster**



PC-P09.85018
Professional Grafting & Pruning Tool

Item No.	Full Length	Packing	Box/CTN	N.W./G.W.	CUFT	CBM
PC-P09.847A	318mm	White Box	12 / 36	11.5 / 15.7	2.75	0.078
PC-P09.85018		Sliding Card	40	16.6 / 17.5	1.90	0.054



PC-B01.8MAC
2-in-1 Sharpening Tool & Can Opener



Item No.	Full Length	Packing	N.W./G.W.	CUFT	CBM
PC-8B01.8MAC	153mm	Sliding Card	3.4 / 4.5	1.08	0.031





SWIVEL GRASS SHEARS

PC-P01.3159

Swivel Grass Shears - Wavy Blade

360° Swivel Blades with 12 cutting positions



PC-P01.3118

Swivel Grass Shears

360° Swivel Blades with 12 cutting positions



PC-P01.3112A

Swivel Grass Shears

180° Swivel Blades



Item No.	Full Length	Packing	Box / CTN	N.W. / G.W.	CUFT
PC-P01.3159	355 mm (14")	Blister Card	6 / 36	16 / 17	2.8
PC-P01.3118	340 mm (13 1/2")	Blister Card	6 / 36	14.5 / 15.5	2.0
PC-P01.3112A	340 mm (13 1/2")	Blister Card	10 / 60	26 / 27	2.7

HEDGE SHEARS & LOPPING SHEARS



47

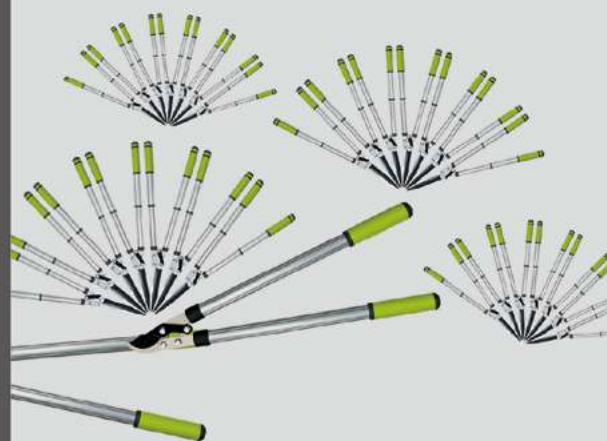

HEDGE SHEARS



Non-Stick
Coated Blade

Light Weight
Aluminum Telescopic
Handle

Non-Slip PP/TPR Grip,
2 Tone Grips



PC-B01.2121QY
Straight Blade Hedge Shears



PC-B01.2122QY
Wavy Hedge Shears



PC-B01.2231QY
Straight Blade Hedge Shears



PC-B01.2232QY
Wavy Blade Hedge Shears

Item No.	Full Length	Packing	CTN	N.W. / G.W.	CUFT
PC-B01.2121QY	60 cm	Bulk	12	12 / 13	1.39
PC-B01.2122QY	60 cm	Bulk	12	12 / 13	1.39
PC-B01.2231QY	60 cm	Bulk	12	12.2 / 13.1	1.56
PC-B01.2232QY	60 cm	Bulk	12	12.2 / 13.1	1.56

**Light Weight Aluminum
Telescopic Handle**



**PC-B01.2121QH
Straight Blade Hedge Shears**



**PC-B01.2122QH
Wavy Blade Hedge Shears**



**PC-B01.2231QH
Straight Blade Hedge Shears**



**PC-B01.2232QH
Wavy Blade Hedge Shears**

Light Weight Aluminum Telescopic Handle

Item No.	Full Length	Packing	CTN	N.W. / G.W.	CUFT
PC-B01.2121QH	65 - 85 cm	Bulk	12	15.0 / 15.8	1.38
PC-B01.2122QH	65 - 85 cm	Bulk	12	15.6 / 16.5	1.38
PC-B01.2231QH	65 - 85 cm	Bulk	12	15.6 / 16.5	1.69
PC-B01.2232QH	65 - 85 cm	Bulk	12	14.4 / 15.4	1.42



PC-B01.2121NR
605mm Compound Straight Hedge Shears



PC-B01.2121TR
690~840mm Telescopic Compound Straight Hedge Shears



PC-B01.2534NR
605mm Gear Wavy Blade Hedge Shears



PC-B01.2534TR
690~835mm Telescopic Gear Wavy Blade Hedge Shears

Item No.	Full Length	Packing	Box/CTN	N.W./G.W.	CUFT	CBM
PC-B01.2121NR	605mm	Bulk	12	12.1 / 13.1	1.10	0.031
PC-B01.2121TR	690 - 840mm	Bulk	12	15.1 / 16.1	1.25	0.035
PC-B01.2534NR	605mm	Bulk	12	11.7 / 12.7	1.45	0.041
PC-B01.2534TR	690 - 835mm	Bulk	12	15.3 / 16.3	1.10	0.031

Light Weight Aluminum Handle



PC-B01.2232NR
605mm Wavy Blade Hedge Shears



PC-B01.2232TR
700~850mm Telescopic Wavy Blade Hedge Shears



PC-B01.2431NR
620mm Power-Lever Straight Hedge Shears



PC-B01.2431TR
705~855mm Telescopic Power-Lever Straight Hedge Shears

Item No.	Full Length	Packing	Box/CTN	N.W./G.W.	CUFT	CBM
PC-B01.2232NR	610mm	Bulk	12	12.7 / 13.7	1.50	0.042
PC-B01.2232TR	700 - 850mm	Bulk	12	15.7 / 16.7	1.75	0.050
PC-B01.2431NR	620mm	Bulk	12	12.1 / 13.1	1.00	0.028
PC-B01.2431TR	705 - 855mm	Bulk	12	15.0 / 16.0	1.55	0.044

**Light Weight Aluminum
Telescopic Handle**



PC-B01.2431QH
**700~890mm Single Cam Telescopic Effortless
Straight Hedge Shears**



PC-B01.2432QH
**700~890mm Single Cam Telescopic Effortless Wavy
Blade Hedge Shears**



PC-B01.2931QH
**700~890mm High Leverage Twin Cam Telescopic
Straight Blade Hedge Shears**



PC-B01.2932QH
**700~890mm High Leverage Twin Cam
Telescopic Wavy Blade Hedge Shears**

Item No.	Full Length	Packing	Box/CTN	N.W./G.W.	CUFT	CBM
PC-B01.2431QH	700 - 890mm	Bulk	12	15.9 / 16.9	1.80	0.051
PC-B01.2432QH	700 - 890mm	Bulk	12	15.9 / 16.9	1.80	0.051
PC-B01.2931QH	700 - 890mm	Bulk	12	16.8 / 17.8	1.80	0.051
PC-B01.2932QH	700 - 890mm	Bulk	12	16.8 / 17.8	1.80	0.051



SHEARING THE SHAPE
YOU'RE DREAMING

LOPPING SHEARS

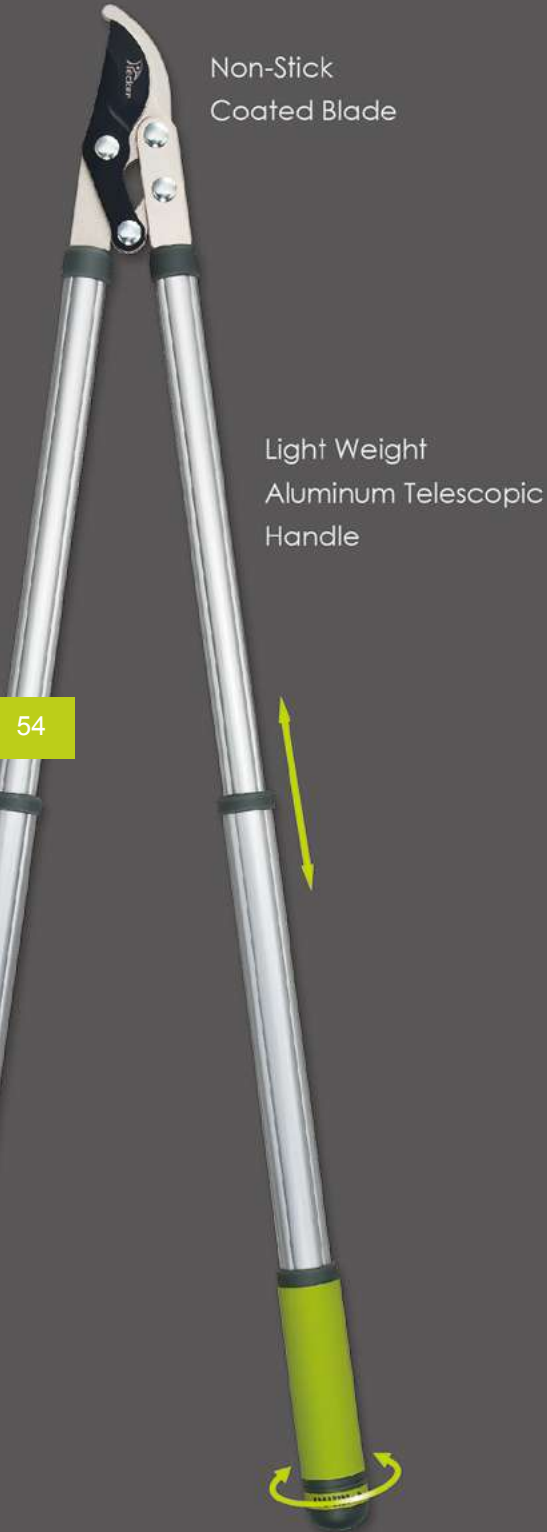

Non-Stick
Coated Blade

Light Weight
Aluminum Telescopic
Handle

54

Non-Slip PP/TPR Grip,
2 Tone Grips



PC-B01.1113QY
Compound-Action Bypass Lopper



PC-B01.1115QY
Compound-Action Anvil Lopper



PC-B01.1130QY
Compound-Action Bypass Lopper

Item No.	Full Length	Cutting Capacity	Packing	CTN	N.W. / G.W.	CUFT
PC-B01.1113QY	70 cm	32 mm	Bulk	12	12 / 13	1.7
PC-B01.1115QY	70 cm	32 mm	Bulk	12	12 / 13	1.7
PC-B01.1130QY	75 cm	38 mm	Bulk	12	16.8 / 17.8	1.7

**Light Weight Aluminum
Telescopic Handle**



PC-B01.1113QH
Compound-Action Bypass Lopper



PC-B01.1115QH
Compound-Action Anvil Lopper



PC-B01.1130QH
Compound-Action Bypass Lopper

Item No.	Full Length	Cutting Capacity	Packing	CTN	N.W. / G.W.	CUFT
PC-B01.1113QH	63 - 95 cm	32 mm	Bulk	12	14.8 / 15.8	1.56
PC-B01.1115QH	63 - 95 cm	32 mm	Bulk	12	14.4 / 15.4	1.91
PC-B01.1130QH	67 - 100 cm	38 mm	Bulk	12	21.6 / 22.6	1.91

LOPPING SHEARS



PC-B01.1131QY
Compound-Action Anvil Lopper



PC-B01.3101QY
Ratchet Anvil Lopper



PC-B01.3110QY
Ratchet Bypass Lopper

Item No.	Full Length	Cutting Capacity	Packing	CTN	N.W. / G.W.	CUFT
PC-B01.1131QY	73 cm	38 mm	Bulk	12	14.4 / 15.4	1.7
PC-B01.3101QY	72 cm	45 mm	Bulk	12	12.7 / 15.0	2.25
PC-B01.3110QY	77 cm	45 mm	Bulk	12	16.9 / 18.2	2.38

**Light Weight Aluminum
Telescopic Handle**



**PC-B01.1131QH
Compound-Action Anvil Lopper**



**PC-B01.3101QH
Ratchet Anvil Lopper**



**PC-B01.3110QH
Ratchet Bypass Lopper**

Item No.	Full Length	Cutting Capacity	Packing	CTN	N.W. / G.W.	CUFT
PC-B01.1131QH	68 - 100 cm	38 mm	Bulk	12	19.2 / 20.2	1.91
PC-B01.3101QH	65 - 95 cm	45 mm	Bulk	12	19.2 / 20.2	1.91
PC-B01.3110QH	65 - 95 cm	45 mm	Bulk	12	19.2 / 20.2	1.91

Light Weight Aluminum
Telescopic Handle

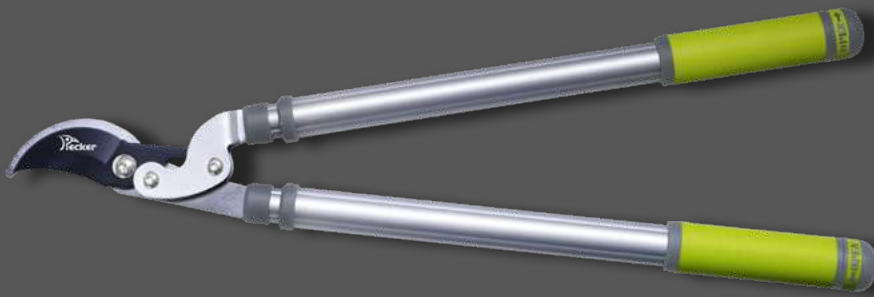

PC-B01.3330QH
685~990mm Single Cam Telescopic Strength-Saving Bypass Lopper



PC-B01.3331QH
675~985mm Single Cam Telescopic Strength-Saving Anvil Lopper

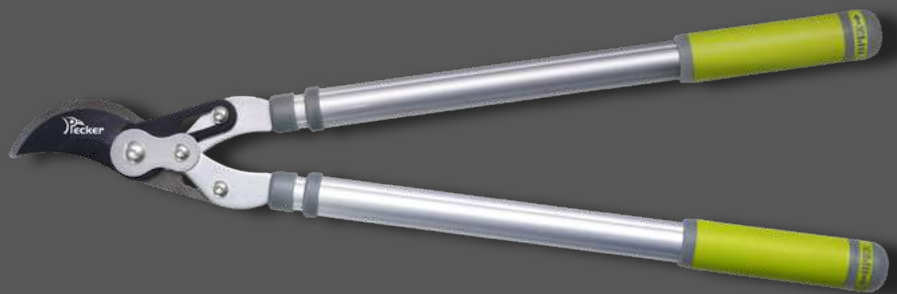

PC-B01.3380QH
700~1020mm Twin Cam Telescopic High Leverage Bypass Lopper

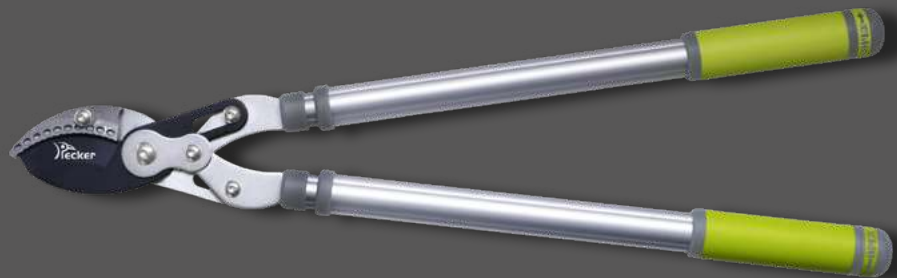

PC-B01.3381QH
700~1020mm Twin Cam Telescopic High Leverage Anvil Lopper

Item No.	Full Length	Packing	Box/CTN	N.W./G.W.	CUFT	CBM
PC-B01.3330QH	685 - 990mm	Bulk	12	18.6 / 19.6	1.80	0.051
PC-B01.3331QH	675 - 985mm	Bulk	12	18.6 / 19.6	1.80	0.051
PC-B01.3380QH	700 - 1020mm	Bulk	12	18.6 / 19.6	1.80	0.051
PC-B01.3381QH	700 - 1020mm	Bulk	12	18.6 / 19.6	1.80	0.051

Light Weight Aluminum
Telescopic Handle



PC-B01.3362RW / PC-B01.3362TW
747mm Large Gear Bypass Lopper / 665~1000mm Telescopic Large Gear Bypass Lopper



PC-B01.3363RW / PC-B01.3363TW
755mm Large Gear Anvil Lopper / 680~1015mm Telescopic Large Gear Anvil Lopper

Item No.	Full Length	Cutting Capacity	Packing	Box/CTN	N.W./G.W.	CUFT	CBM
PC-B01.3362RW	747mm	30mm	Bulk	12	15.6 / 16.6	1.80	0.051
PC-B01.3362TW	665 - 1000mm	30mm	Bulk	12	18.0 / 19.0	1.80	0.051
PC-B01.3363RW	755mm	40mm	Bulk	12	19.2 / 20.2	1.80	0.051
PC-B01.3363TW	680 - 1015mm	40mm	Bulk	12	19.2 / 20.2	1.80	0.051

**Light Weight Aluminum
Telescopic Handle**

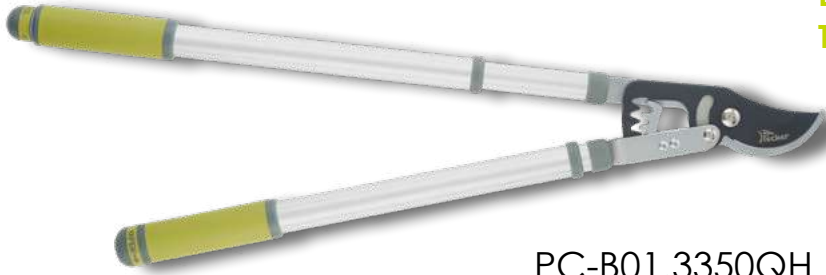

PC-B01.3350QH
695~1015mm Gear Telescopic Bypass Lopper



PC-B01.3350QY
770mm Gear Bypass Lopper



PC-B01.3351QH
702~1022mm Gear Telescopic Anvil Lopper

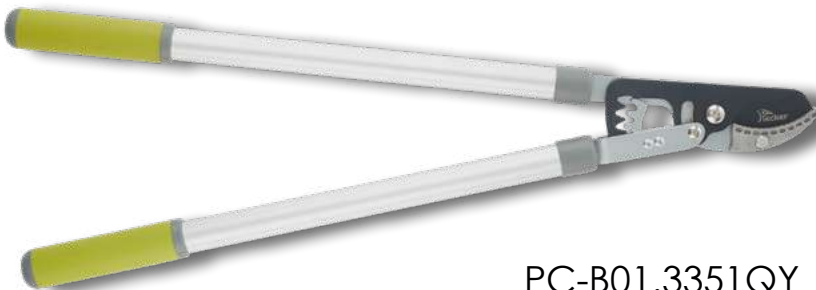

PC-B01.3351QY
780mm Gear Anvil Lopper

Item No.	Full Length	Cutting Capacity	Packing	Box/CTN	N.W./G.W.	CUFT	CBM
PC-B01.3350QH	695 - 1015mm	35mm	Bulk	12	18.6 / 19.6	1.80	0.051
PC-B01.3350QY	770mm	35mm	Bulk	12	15.6 / 16.6	1.80	0.051
PC-B01.3351QH	702 - 1022mm	38mm	Bulk	12	19.2 / 20.2	1.80	0.051
PC-B01.3351QY	780mm	38mm	Bulk	12	15.6 / 16.6	1.80	0.051

Light Weight Aluminum Handle



PC-B01.3352NR / PC-B01.3352TR
740mm Gear Bypass Lopper / 660~910mm Telescopic Gear Bypass Lopper



PC-B01.3353NR / PC-B01.3353TR
740mm Gear Anvil Lopper / 660~910mm Telescopic Gear Anvil Lopper

Item No.	Full Length	Cutting Capacity	Packing	Box/CTN	N.W./G.W.	CUFT	CBM
PC-B01.3352NR	740mm	40mm	Bulk	12	14.8 / 15.8	1.85	0.052
PC-B01.3352TR	660 - 910mm	40mm	Bulk	12	16.4 / 17.4	2.15	0.061
PC-B01.3353NR	740mm	40mm	Bulk	12	14.8 / 15.8	1.85	0.052
PC-B01.3353TR	660 - 910mm	40mm	Bulk	12	16.3 / 17.3	2.15	0.061

Strong Fiberglass Tubular Handles



PC-B01.1111RS
Compound-Action Anvil Lopper



PC-B01.2127RS
Straight Blade Hedge Shear



PC-B01.1113T4
Compound-Action Bypass Lopper



PC-B01.1115T4
Compound-Action Anvil Lopper



PC-B01.2232T1
Wavy Blade Hedge Shear

Item No.	Full Length	Cutting Capacity	Packing	CTN	N.W. / G.W.	CUFT
PC-B01.1111RS	53 cm	28 mm	Bulk	12	6.9 / 7.5	0.85
PC-B01.2127RS	52 cm	-	Bulk	12	7.7 / 8.2	0.65

Item No.	Full Length	Cutting Capacity	Packing	CTN	N.W. / G.W.	CUFT
PC-B01.1113T4	56 cm	32 mm	Bulk	12	9.6 / 10.6	1.34
PC-B01.1115T4	56 cm	32 mm	Bulk	12	9.6 / 10.6	1.34
PC-B01.2232T1	59 cm	-	Bulk	12	12 / 13	1.47

Strong Fiberglass Tubular Handles



PC-B01.2831T6
745mm Gear Straight Hedge Shears



PC-B01.3500T6
700mm Gear Bypass Lopper



PC-B01.3501T6
690mm Gear Anvil Lopper

Item No.	Full Length	Cutting Capacity	Packing	Box/CTN	N.W./G.W.	CUFT	CBM
PC-B01.2831T6	745mm		Bulk	12	13.8 / 14.8	1.40	0.040
PC-B01.3500T6	700mm	30mm	Bulk	12	13.0 / 14.0	1.80	0.051
PC-B01.3501T6	690mm	32mm	Bulk	12	12.0 / 13.0	1.80	0.051



PC-P09.2732T9
675mm Fiberglass Wavy Hedge Shears



PC-P09.1502T9
535mm Fiberglass Bypass Lopper

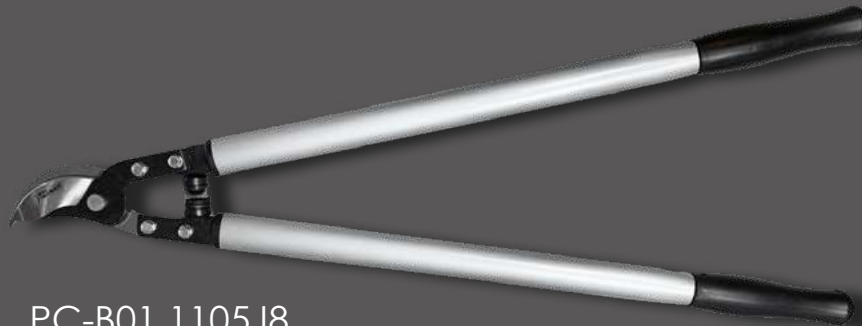

PC-B01.1105J8
Robust Bypass Lopper

Item No.	Full Length	Cutting Capacity	Packing	Box/CTN	N.W./G.W.	CUFT	CBM
PC-P09.2732T9	675mm		Bulk	12	102. / 11.2	1.40	0.040
PC-P09.1502T9	535mm		Bulk	12	9.1 / 10.1	1.10	0.031
PC-B01.1105J8-505	505mm	30mm	Bulk	12	11.5 / 12.5	1.5	0.043
PC-B01.1105J8-605	605mm	30mm	Bulk	12	12.1 / 13.1	1.6	0.045
PC-B01.1105J8-905	905mm	30mm	Bulk	12	13.1 / 14.1	2.0	0.057



PC-P02.1162-50
500mm Bypass Lopper



PC-P02.1163P-60
600mm Professional Bypass Lopper



PC-P02.1163F-70
700mm Professional Bypass Lopper



PC-P02.1163A-61
510mm Hedge Shear

Item No.	Full Length	Cutting Capacity	Packing	CTN	N.W. / G.W.	CUFT
PC-P02.1162-50	50 cm	25 mm	Bulk	12	8.9 / 9.3	0.90
PC-P02.1163P-60	60 cm	40 mm	Bulk	12	9.0 / 10.0	1.07
PC-P02.1163F-70	70 cm	35 mm	Bulk	12	8.6 / 9.6	1.10
PC-P02.1163A-61	51 cm	For Grass	Bulk	12	9.0 / 10.0	2.10

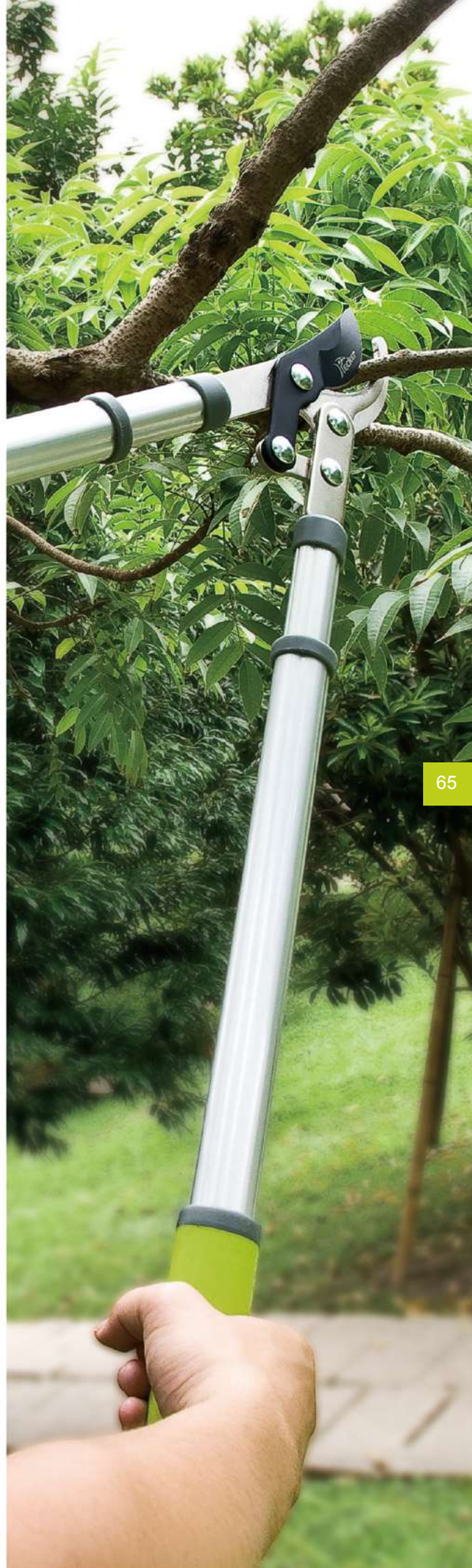



PC-B01.1028Z1
Classic Topiary Hedge Shears



PC-B01.1038
Ultralight Straight Blade Hedge Shears

Item No.	Full Length	Packing	Box/CTN	N.W./G.W.	CUFT	CBM
PC-B01.1028Z1-8	650mm (25.5")	Bulk	12	10.0 / 11.0	1.40	0.040
PC-B01.1028Z1-10	700mm (27.5")	Bulk	12	11.0 / 12.0	1.40	0.040
PC-B01.1038-8	750mm (29.5")	Bulk	12	11.3 / 12.3	1.40	0.040
PC-B01.1038-10	800mm (31.5")	Bulk	12	11.8 / 12.8	1.40	0.040

MINI GARDEN TOOLS

P.P. HANDLE WITH TPR GRIP
STAINLESS STEEL



PC-G02.2418S



PC-G02.6013S



PC-G02.5085S



PC-G02.5091S



PC-G02.6020S



PC-G02.101S



PC-G02.102S



PC-G02.0801

Adjustable Bulb Planter

Item No.	Description	Box / CTN	N.W. / G.W.	CUFT
PC-G02.2418-S	Hand Lever Weeder	12 / 72	15 / 16	1.6
PC-G02.6013-S	3 Prong Cultivator	12 / 72	17 / 18	1.8
PC-G02.5085-S	Weeding Fork	12 / 72	15.6 / 16.6	1.3
PC-G02.5091-S	Garden Trowel	12 / 48	17.7 / 18.7	2.4
PC-G02.6020-S	Garden Trowel	12 / 72	16 / 17	2.0
PC-G02.101-S	Garden Trowel	12 / 72	19 / 20	1.8
PC-G02.102-S	Transplanter	12 / 72	12.5 / 13.5	1.3
PC-G02.0801	Adjustable Bulb Planter	12 / 60	18.6 / 19.6	3.2
PC-G07.1511A	9 Flat Tine Rake	10 / 60	10.2 / 12.5	1.4
PC-G07.1511B	Transplanter	10 / 60	11 / 12.6	1.4
PC-G07.1511C	Garden Trowel	10 / 60	11.8 / 13.6	1.6
PC-G07.1511D	5 Flat Tine Cultivator	10 / 60	9.6 / 11.5	1.6
PC-G07.1511E	3 Prong Cultivator	10 / 60	10.8 / 13	1.7
PC-G07.1511F	Hoe Weeding & 3 Prong	10 / 60	16.2 / 18.6	3.2



PC-G07.1511A



PC-G07.1511B



PC-G07.1511C



PC-G07.1511D



PC-G07.1511E



PC-G07.1511F

Plastic comfortable Handle

MINI GARDEN TOOLS

Item No.	Description	Full Length	Packing	Box / CTN	N.W. / G.W.	CUFT
PC-G02.134P-C	Hand Weeder	311 mm (12 1/4")	Bulk	12 / 72	9.8 / 10.8	1.0
PC-G02.107P-C	Hoe Weeding & 3 Prong	292 mm (11 1/2")	Bulk	12 / 72	20.0 / 21.0	3.0
PC-G02.6631P-C	Garden Trowel	349 mm (13 3/4")	Bulk	12 / 72	20.0 / 21.0	2.4
PC-G02.2430P-C	5 Flat Tine Cultivator	295 mm (11 5/8")	Bulk	12 / 72	14.5 / 15.5	1.8
PC-G02.6013P-C	3 Teeth Rake	305 mm (12")	Bulk	12 / 72	16.5 / 17.5	1.7
PC-G02.7019P-C	9 Flat Tine Rake	406 mm (16")	Bulk	12 / 72	17.0 / 18.0	2.0
PC-G02.240P-C	Paving Stone Weeder	270 mm (10 5/8")	Bulk	12 / 72	9.6 / 10.6	1.5





MINI GARDEN TOOLS

Item No.	Description	Full Length	Packing	Box / CTN	N.W. / G.W.	CUFT
PC-G02.240W-C	Paving Stone Weeder	270 mm (10 5/8")	Bulk	12 / 72	8.0 / 9.0	-
PC-G02.7019W-C	9 Flat Tine Rake	381 mm (15")	Bulk	12 / 72	12.7 / 13.7	-
PC-G02.6013W-C	3 Teeth Rake	305 mm (12")	Bulk	12 / 72	16.5 / 17.5	1.7
PC-G02.2430W-C	5 Flat Tine Cultivator	282 mm (11 1/8")	Bulk	12 / 48	15.2 / 16.2	1.8
PC-G02.6631W-C	Garden Trowel	349 mm (13 3/4")	Bulk	12 / 72	20.0 / 21.0	2.4
PC-G02.107W-C	Hoe Weeding & 3 Prong	280 mm (11")	Bulk	12 / 72	18.5 / 19.5	2.8
PC-G02.134W-C	Hand Weeder	311 mm (12 1/4")	Bulk	12 / 72	9.8 / 10.8	1.0



PC-G01.T308-1
Narrow Transplanter



PC-G01.T308-2
Potting Scoop



PC-G01.T308-3
Garden Sieve



PC-G01.T308-4
Square Hand Scoop



PC-G01.T308-5
5-Tine Cultivator Hand Tool



PC-G01.T308-6
6-Tine Bear Paws Cultivator



PC-G01.T308-7
Triangle Scoop



PC-G01.T501W
Garden Hand Scoop,
Handle Adj.



PC-G01.T731A
Garden Rolling Manual Tiller

Item No.	Full Length / Size	Packing
PC-G01.T308-1	337mm	Bulk
PC-G01.T308-2	325mm	Bulk
PC-G01.T308-3	334mm	Bulk
PC-G01.T308-4	323mm	Bulk
PC-G01.T308-5	290mm	Bulk

Item No.	Full Length / Size	Packing
PC-G01.T308-6	264mm	Bulk
PC-G01.T308-7	315mm	Bulk
PC-G01.T501W	460mm	Bulk
PC-G01.T731A	310x230mm	Bulk

PC-G01.T750
Fruit Picking Tool



PC-G01.T772
Manual Weeding Hoe,
Angle Adjustable



PC-G01.T892F
12T Lightweight, Double-
Sided Spike-Tooth & Sand
Rake



PC-G01.T893
Triangle Garden Hoe



PC-G01.T897
6T Multi-Purpose
Weeder Rake



Item No.	Full Length / Size	Packing
PC-G01.T750	Φ120x240mm	Bulk
PC-G01.T772	159mm	Bulk
PC-G01.T892F	325x140mm	Bulk

Item No.	Full Length / Size	Packing
PC-G01.T893	220x145mm	Bulk
PC-G01.T897	170x180mm	Bulk

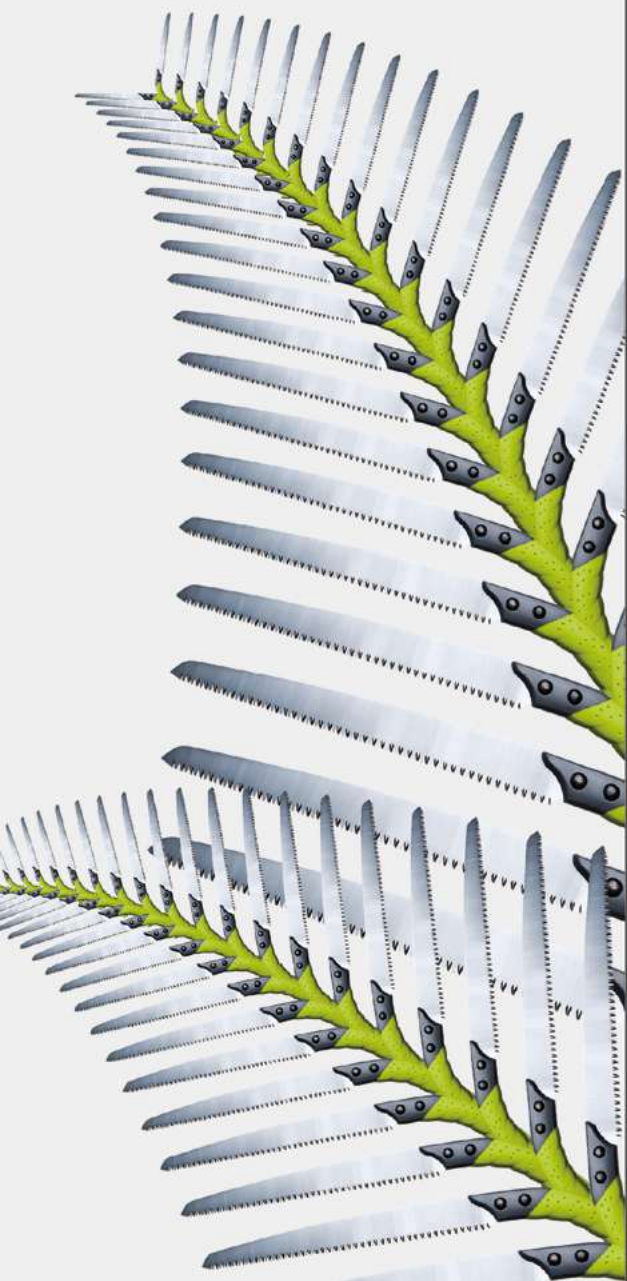

PRUNING SAWS

Item No.	Full Length	Box / CTN	N.W. / G.W.	CUFT
PC-S01.9561	180 mm	12 / 48	12 / 13	2.6
PC-S01.8077	250 mm	6 / 24	11 / 12	2.8
PC-S03.8066	240 mm	12 / 48	16.8 / 18.3	4.43
PC-S03.8066-1	270 mm	12 / 48	17.7 / 19.0	4.64
PC-S03.8066-2	300 mm	12 / 48	18.8 / 20.3	4.98
PC-S03.8066-3	330 mm	12 / 48	19.1 / 20.6	5.08
PC-S03.8088	330 mm	12 / 48	12.6 / 14.7	2.57



PRUNING SAW

PC-S01.9561
Folding Pruning Saw



PC-S01.8077
Pruning Saw with Sheath



PC-S03.8066
Pruning Saw



PC-S03.8088
Pruning Saw





AC-AH01.8099
Sharp & Firm Pruning Saw



AC-AH01.8024
160mm EX Light Portable Garden Pruning Saw

Item No.	Full Length	Packing	Box/CTN	N.W./G.W.	CUFT	CBM
AC-AH01.8099-250	250mm	Color Sleeve	12/72	14.0 / 15.0	2.50	0.071
AC-AH01.8099-270	270mm	Color Sleeve	12/72	14.0 / 15.0	2.50	0.071
AC-AH01.8099-300	300mm	Color Sleeve	12/72	14.0 / 15.0	2.50	0.071
AC-AH01.8024	355mm	Sliding Card	12/72	9.0 / 10.0	2.50	0.071



LONG REACH PRUNERS

PC-P02.598LNR-1
Tree Pruner
 with Rotating blade head



Pull the knob to swivel blade head



Adjust different angle as you wish



Two easy ways to make pruning cut



Cut!



Item No.	Full Length	Packing	CTN	N.W. / G.W.	CUFT
PC-P02.598LNR-1	160 cm	Bulk	12	12 / 13	3.25
PC-P02.599LNR-1	160 cm	Bulk	12	12 / 13	3.25
PC-P02.598LND-1	160 cm	Bulk	12	11.4 / 12.4	2.62



PC-P02.599LNR-1
Tree Pruner
with Rotating blade head



PC-P02.598LND-1
Tree Pruner





TREE PRUNERS

Item No.	CTN	N.W. / G.W.	CUFT
PC-S08.TP02	12	10.0 / 11.0	1.30
PC-S08.TP03	12	10.0 / 11.0	1.30
PC-S08.TP02-4	12	10.0 / 11.0	1.30
PC-S08.TP03-4	12	10.0 / 11.0	1.30
PC-B01.810S	12	11.4 / 12.9	1.9



PC-S08.TP02
2 Pulleys
Tree Pruner



PC-S08.TP03
2 Pulleys
Tree Pruner



PC-S08.TP02-4
4 Pulleys
Tree Pruner



PC-S08.TP03-4
4 Pulleys
Tree Pruner



PC-B01.810S
Tree Pruner





PC-B01.795TP
Pole Saw, Two Hook

Item No.	Packing	Box/CTN	N.W./G.W.	CUFT	CBM
PC-B01.795TP	Double Blister	12	7.1 / 7.8	1.10	0.031



PC-B01.892TP
Tree Pruner Saw Head Kit

Item No.	Packing	Box/CTN
PC-B01.892TP	Double Blister	12

AXE, MACHETE



AC-H06.AU320440
Camping Hatchet, ca. 600g



PC-B01.8X1A1
Camping Axe



PC-B01.842NC
4mm Machete



PC-B01.843NC
3mm Sickle



PC-B01.842V6
4mm Machete



PC-B01.843V6
3mm Sickle



PC-B01.849V5
3mm Machete

Item No.	Full Length / Size	Packing
AC-AH06.BU230440	23cm	Bulk
AC-AH06.BU250440	25cm	Bulk
AC-AH06.AU320440	32cm	Bulk
AC-AH06.AU500710	50cm	Bulk
AC-AH06.AS500950	50cm	Bulk
AC-AH06.AU711300	71cm	Bulk
AC-AH06.AS711700	71cm	Bulk
AC-AH06.B92S	92cm	Bulk

Item No.	Full Length / Size	Packing
PC-B01.8X1A1	32cm	Bulk
PC-B01.842NC-1	44.5cm	Bulk
PC-B01.842NC-2	59cm	Bulk
PC-B01.843NC-1	45.5cm	Bulk
PC-B01.843NC-2	60cm	Bulk
PC-B01.842V6	46cm	Bulk
PC-B01.843V6	47cm	Bulk
PC-B01.849V5	49.5cm	Bulk

RAKES



Flat Tine

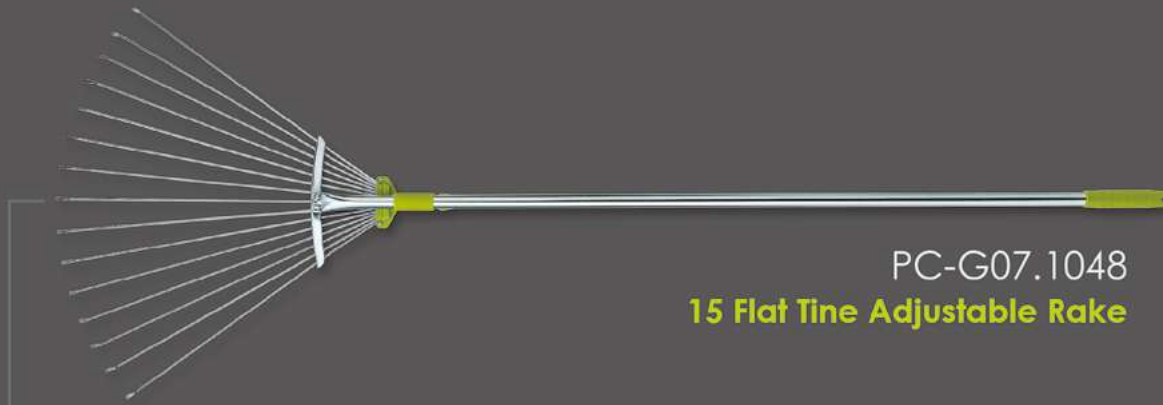

PC-G07.1048
15 Flat Tine Adjustable Rake

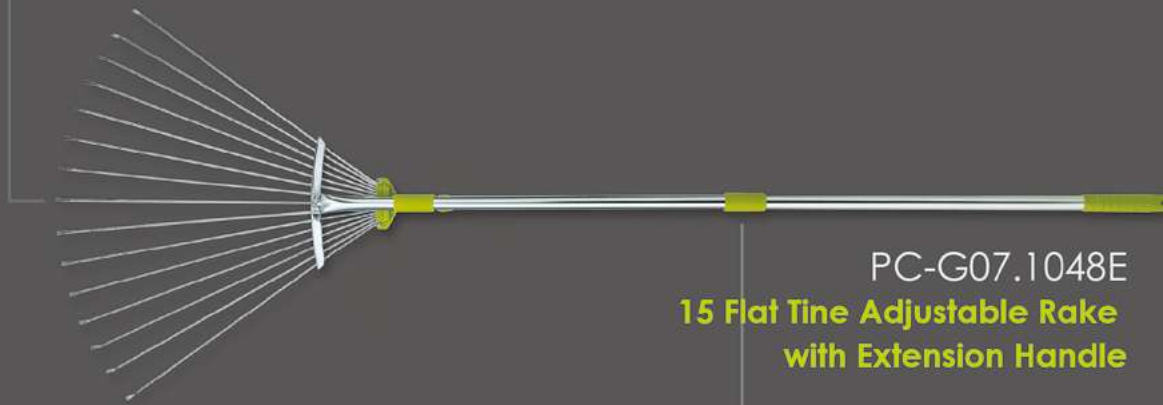

PC-G07.1048E
**15 Flat Tine Adjustable Rake
with Extension Handle**

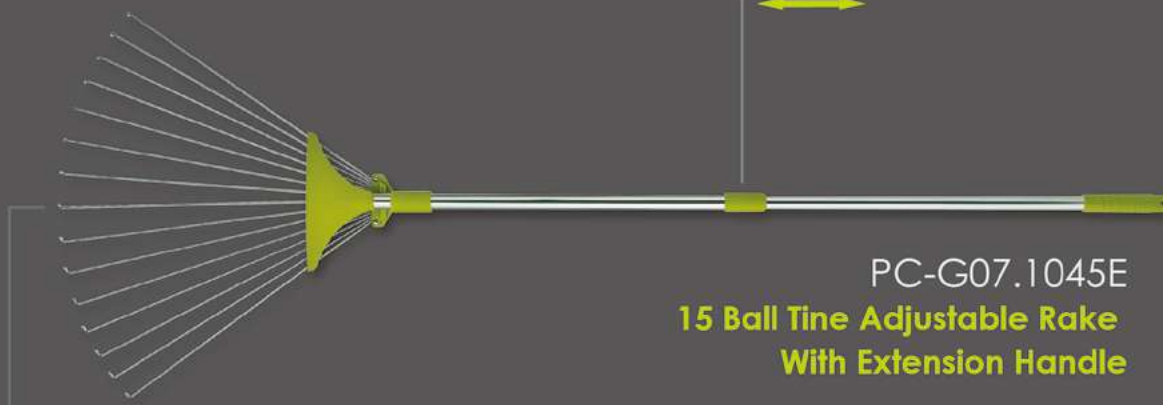

PC-G07.1045E
**15 Ball Tine Adjustable Rake
With Extension Handle**



Ball Tine



PC-G07.1045S
9 Ball Tine Adjustable Rake

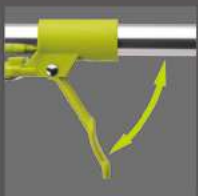

Lock
Adjustable the Width

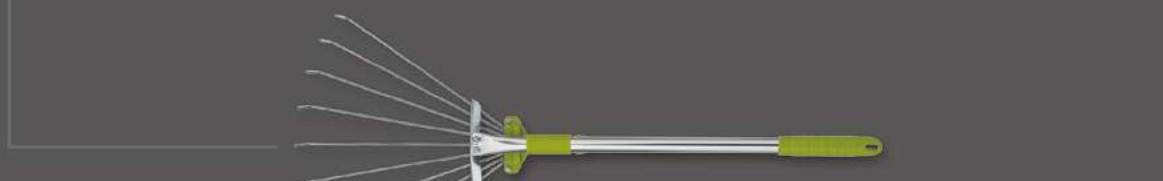

PC-G07.1047
9 Ball Tine Adjustable Rake

Item No.	Full Length	Packing	CTN	N.W. / G.W.	CUFT
PC-G07.1048	160 cm	Bulk	12	7.2 / 8.2	1.6
PC-G07.1048E	110 - 153 cm	Bulk	18	16.5 / 17.5	2.4
PC-G07.1045E	110 - 153 cm	Bulk	18	18 / 19	2.4
PC-G07.1045S	72 cm	Bulk	12	4.0 / 4.5	1.5
PC-G07.1047	72 cm	Bulk	24	10 / 10.8	1.5

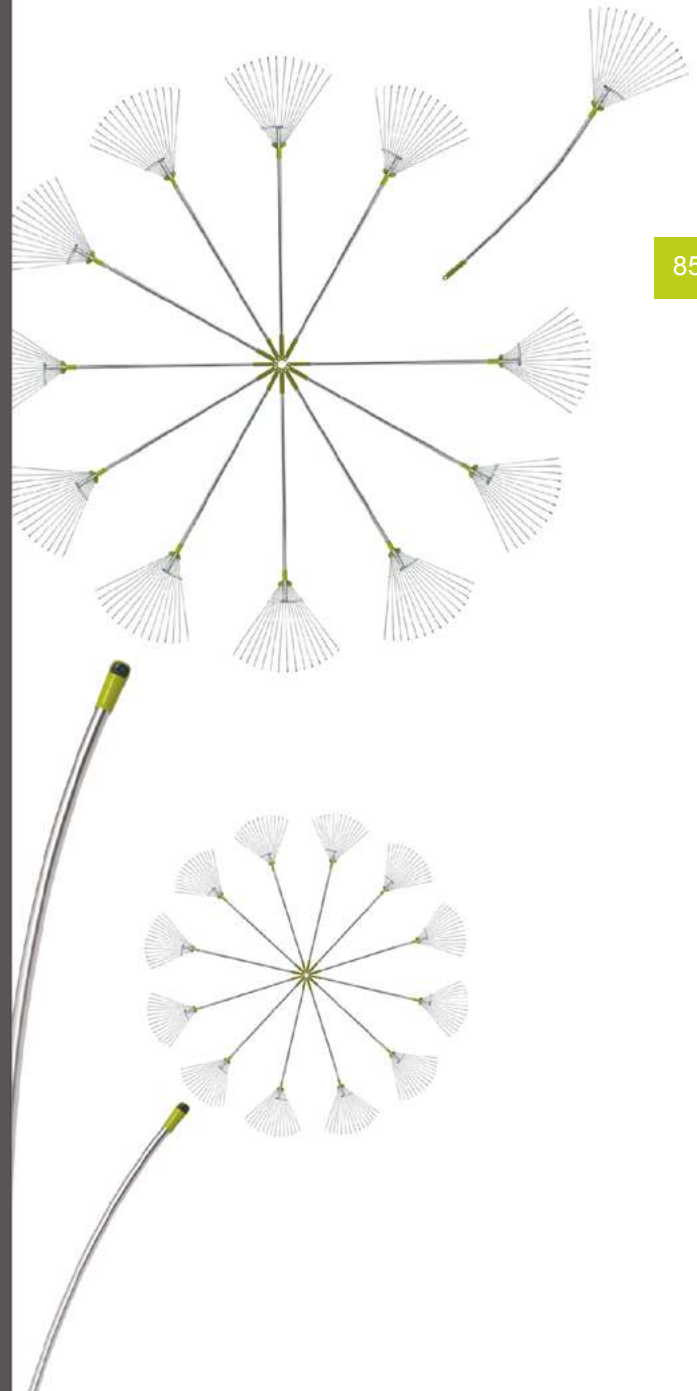



PC-G06.12
12 Teeth Solid Steel Rake



PC-G06.14
14 Teeth Solid Steel Rake



PC-G06.14N
Twisted Tooth Garden Rake 14T



PC-G06.22
L Type Steel Dibber

Item No.	Full Length / Size	Packing
PC-G06.12	12T	Bulk
PC-G06.14	14T	Bulk
PC-G06.14N	14T	Bulk
PC-G06.22		Bulk

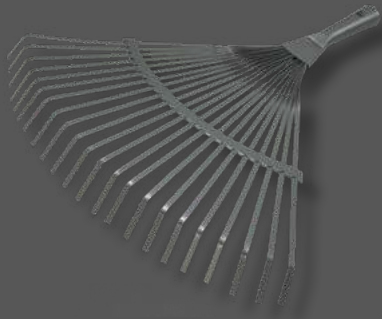

PC-G06.40
22 Flat Teeth Fan Wire Rake



PC-G06.42
22 Flat Teeth Sliding Fan Wire Rake

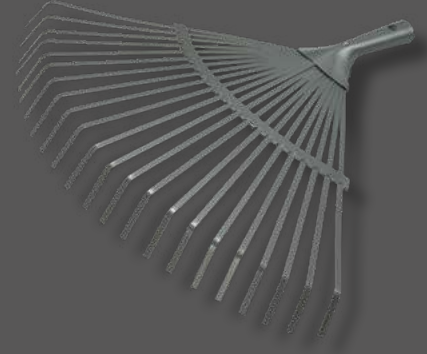

PC-G06.46
22 Flat Teeth Fan Wire Rake

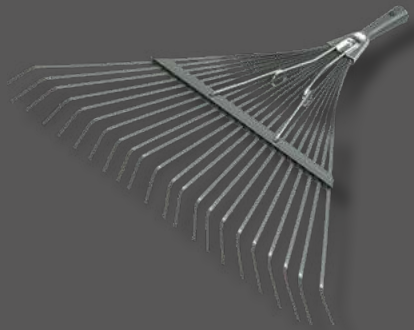

PC-G06.56
22 Flat Teeth Spring Wire Rake

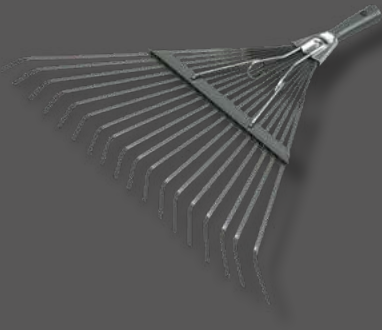

PC-G06.57
18 Flat Teeth Spring Wire Rake

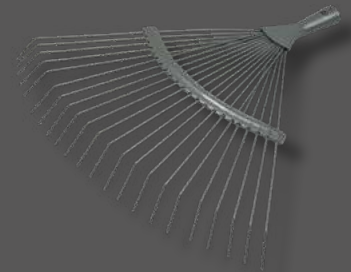

PC-G06.72
22 Round Teeth Fan Wire Rake

Item No.	Full Length / Size	Packing
PC-G06.40	22T	Bulk
PC-G06.42	22T	Bulk
PC-G06.46	22T	Bulk
PC-G06.56	22T	Bulk
PC-G06.57	18T	Bulk
PC-G06.72	22T	Bulk



WATERING THE FLOWERS
WITH YOUR LOVE

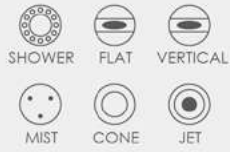

PC-W01.73316E

PC-W01.74316E

6 Pattern Water Wand

Front-pull Flow-control Plastic Handle with 3/4" Plastic Male Adapter



PC-W01.73318E

PC-W01.74318E

8 Pattern Water Wand

Front-pull Flow-control Plastic Handle with 3/4" Plastic Male Adapter



PC-W01.73348E

PC-W01.74348E

8 Pattern Water Wand

Front-pull Flow-control Metal Handle with 3/4" Plastic Male Adapter

Item No.	Full Length	Packing	Box / CTN	N.W. / G.W.	CUFT
PC-W01.73316E	71 cm (28")	Head Card	5 / 20	5.8 / 6.8	3.95
PC-W01.74316E	71 - 104 cm (28" - 41")	Head Card	5 / 10	4.3 / 5.3	1.69
PC-W01.73318E	71 cm (28")	Head Card	5 / 20	5.6 / 6.6	3.32
PC-W01.74318E	71 - 104 cm (28" - 41")	Head Card	5 / 10	3.3 / 4.8	1.69
PC-W01.73348E	71 cm (28")	Head Card	5 / 10	4 / 5	1.69
PC-W01.74348E	71 - 104 cm (28" - 41")	Head Card	5 / 10	4.8 / 5.8	1.69



PC-W04.65017E

PC-W04.65011-01E

**18"/450mm 10 Pattern
Thumb Control Water Wand**

**36"/900mm 10 Pattern
Thumb Control Water Wand**



PC-W04.65113E

PC-W04.65123E

**18"/450mm 3 Pattern Turbo Cleaning
Wand, Thumb Control Type**

**28"/710mm 3 Pattern Turbo Cleaning
Wand, Thumb Control Type**

Item No.	Packing	Box/CTN	CUFT	CBM
PC-W04.65017E	Tied On Card	6	1.23	0.035
PC-W04.65011-01E	Tied On Card	6	2.40	0.068
PC-W04.65113E	Tied On Card	6	1.23	0.035
PC-W04.65123E	Tied On Card	6	1.23	0.035



PC-W02.15972E
7 Pattern Metal Front Trigger Nozzle
 with Plastic Adaptor



PC-W02.15130E
3 Way Fire Lady's Front Trigger Nozzle
 with Plastic Adaptor



PC-W02.15780E
8 Pattern Metal Front Trigger Nozzle
 with Plastic Adaptor



PC-W02.15834E
3 Way Metal Front Trigger Nozzle
 with Plastic Adaptor

Item No.	Packing	Box / CTN	N.W. / G.W.	CUFT
PC-W02.15972E	Tied On Card	6 / 24	10.2 / 11.2	1.60
PC-W02.15130E	Tied On Card	6 / 24	7.7 / 10.3	1.60
PC-W02.15780E	Tied On Card	6 / 24	11.0 / 12.0	1.80
PC-W02.15834E	Tied On Card	6 / 24	7.7 / 10.0	1.30



PC-W02.12184E
7 Pattern Plastic Trigger Nozzle
 with Plastic Adaptor



PC-W02.11130E
3 Way Plastic Nozzle
 with Plastic Adaptor



PC-W02.12182E
8 Pattern Plastic Nozzle
 with Plastic Adaptor



PC-W02.12432E
3 Way Plastic Nozzle
 with Plastic Adaptor

Item No.	Packing	Box / CTN	N.W. / G.W.	CUFT
PC-W02.12184E	Tied On Card	10 / 60	14.0 / 15.5	3.60
PC-W02.11130E	Tied On Card	10 / 60	11.0 / 12.3	2.40
PC-W02.12182E	Tied On Card	10 / 60	14.0 / 15.6	4.10
PC-W02.12432E	Tied On Card	10 / 60	12.0 / 13.8	3.60



PC-W02.12282E
8 Pattern Nozzle
 with Plastic Hose Adaptor



PC-W02.12832E
Brass Tip Water Nozzle
 with Plastic Adaptor



PC-W02.12110E
Fan Water Nozzle
 with Plastic Adaptor



PC-W02.12112E
Fan Water Nozzle
 with Plastic Adaptor

Item No.	Packing	Box / CTN	N.W. / G.W.	CUFT
PC-W02.12282E	Tied On Card	12 / 48	14.0 / 15.0	2.90
PC-W02.12832E	Tied On Card	12 / 48	15.7 / 16.7	2.10
PC-W02.12110E	Tied On Card	12 / 48	13.1 / 14.2	3.20
PC-W02.12112E	Tied On Card	12 / 48	13.1 / 14.2	3.20



PC-W02.15710E
Fan Water Nozzle
with Plastic Adaptor



PC-W02.15631E
Heavy Duty Fireman's Nozzle
with Plastic Adaptor



PC-W02.15630E
Heavy Duty Fireman's Nozzle
with Plastic Adaptor

Item No.	Packing	Box / CTN	N.W. / G.W.	CUFT
PC-W02.15710E	Tied On Card	10 / 72	24.7 / 26.0	3.60
PC-W02.15631E	Tied On Card	6 / 12	5.5 / 6.3	1.80
PC-W02.15630E	Tied On Card	6 / 48	16.0 / 18.	3.10

PC-W02.658PE
9 Pattern Plastic Nozzle



PC-W02.657PE
Adjustable 3-Way Plastic Nozzle



PC-W02.758PE
8 Pattern Plastic Nozzles



PC-W02.757PE
Adjustable Plastic Nozzle



PC-W02.758ZE
9 Pattern Metal Nozzle



PC-W02.757ZE
Adjustable Metal Nozzle



Item No.	Packing	Box/CTN	N.W./G.W.	CUFT	CBM
PC-W02.658PE	Tied On Card	12 / 72	11.6 / 13.0	3.30	0.093
PC-W02.657PE	Tied On Card	12 / 72	13.2 / 14.5	2.70	0.076
PC-W02.758PE	Tied On Card	12 / 48	9.9 / 11.0	3.20	0.091
PC-W02.757PE	Tied On Card	12 / 48	8.8 / 9.8	2.05	0.058
PC-W02.758ZE	Tied On Card	12 / 48	17.0 / 18.3	3.20	0.091
PC-W02.757ZE	Tied On Card	12 / 48	15.7 / 17.0	2.05	0.058



PC-W04.76571E
7 Pattern Ultra Light Thumb
Control Spray Nozzle



PC-W04.76533E
3 Pattern Ultra Light Thumb
Control Fireman Nozzle



PC-W04.76531E
3 Pattern Ultra Light Thumb
Control Adj. Nozzle



PC-W04.70115A
Comfort Twist Nozzle,
3 Pattern



PC-W04.70114A
Comfort Twist Nozzle, with
Water Flow Control Knob



PC-W02.756WNE
9 Pattern Plastic Nozzle

Item No.	Packing	Box/CTN	N.W./G.W.	CUFT	CBM
PC-W04.76571E	Tied On Card	12 / 48		3.03	0.086
PC-W04.76533E	Tied On Card	12 / 48		3.03	0.086
PC-W04.76531E	Tied On Card	12 / 48		1.65	0.047
PC-W04.70115A	Tied On Card	10 / 200		2.80	0.079
PC-W04.70114A	Tied On Card	10 / 200		2.80	0.079
PC-W02.756WNE	Tied On Card	12 / 48	13.1 / 14.2	3.20	0.091



PC-W04.72719E
**3 Pattern Turbo Cleaning
 Nozzle Rear-Trigger Type**



PC-W04.76522E
**3 Pattern Turbo Cleaning
 Nozzle Thumb Control Type**



PC-W04.72763E
**6 Pattern Turbo Cleaning
 Nozzle Rear-Trigger Type**



PC-W04.76565E
**6 Pattern Turbo Cleaning
 Nozzle Thumb Control Type**

Item No.	Packing	Box/CTN	N.W./G.W.	CUFT	CBM
PC-W04.72719E	Tied On Card	12 / 48		1.65	0.047
PC-W04.76522E	Tied On Card	12 / 48		1.65	0.047
PC-W04.72763E	Tied On Card	12 / 48	17.9 / 18.4	3.03	0.086
PC-W04.76565E	Tied On Card	12 / 48		3.03	0.086

PC-W01.56228E
8 Pattern Metal Spray Nozzle
 with 3/4" Plastic Male Adapter



PC-W01.56223E
Adjustable Brass Head Metal Spray Nozzle
 with 3/4" Plastic Male Adapter

PC-W01.59626E
6 Pattern Metal Nozzle
 with 3/4" Plastic Male Adapter

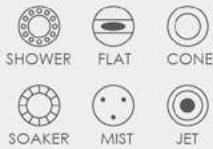

PC-W01.59623E
Adjustable Brass Head Metal Trigger
 with 3/4" Plastic Male Adapter

PC-W01.53568E
8 Pattern Plastic Trigger Nozzle
 with 3/4" Plastic Male Adapter



PC-W01.53563E
Adjustable Brass Pistol Nozzle
 with 3/4" Plastic Male Adapter

Item No.	Packing	Box / CTN	N.W. / G.W.	CUFT
PC-W01.56228E	Tied On Card	12 / 48	11.7 / 12.7	2.00
PC-W01.56223E	Tied On Card	12 / 48	12.5 / 13.5	1.18
PC-W01.59626E	Tied On Card	12 / 48	11.5 / 12.5	2.00
PC-W01.59623E	Tied On Card	12 / 48	9.9 / 10.9	1.4
PC-W01.53568E	Tied On Card	6 / 48	13.7 / 15.2	2.57
PC-W01.53563E	Tied On Card	6 / 48	13.3 / 14.8	2.08



PC-W01.56215E
6 Pattern Plastic Spray Nozzle
 with 3/4" Plastic Male Adapter

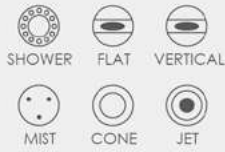

PC-W01.56218E
8 Pattern Plastic Spray Nozzle
 with 3/4" Plastic Male Adapter



PC-W01.56213E
Adjustable Plastic Head Plastic Spray Nozzle
 with 3/4" Plastic Male Adapter



PC-W01.51028E
8 Pattern Insulated Metal Trigger Nozzle
 with 3/4" Plastic Male Adapter



PC-W01.51021E
3 Way Insulated Metal Trigger Nozzle
 with Protective Cap
 with 3/4" Plastic Male Adapter



PC-W01.51023E
Adjustable Brass Head Metal Trigger Nozzle
 with 3/4" Plastic Male Adapter

Item No.	Packing	Box / CTN	N.W. / G.W.	CUFT
PC-W01.56215E	Tied On Card	12 / 48	8.8 / 9.9	2.78
PC-W01.56218E	Tied On Card	12 / 48	7.8 / 8.8	2.08
PC-W01.56213E	Tied On Card	12 / 48	6 / 7.1	1.45
PC-W01.51028E	Tied On Card	12 / 48	13.9 / 14.9	2.1
PC-W01.51021E	Tied On Card	12 / 48	13 / 14	1.53
PC-W01.51023E	Tied On Card	12 / 48	14.8 / 15.8	1.48

SPRINKLERS





PC-W01.30410
Plastic Impulse Sprinkler
 (full circle)



PC-W01.30100
Plastic Impulse Sprinkler
 (full or part circle)



PC-W01.30119
Inter-Jet Plastic Impulse Sprinkler
 (full or part circle)

Item No.	Packing	Box / CTN	N.W. / G.W.	CUFT
PC-W01.30410	Tied On Card	12 / 48	2.1 / 3.6	1.2
PC-W01.30100	Tied On Card	12 / 48	3.3 / 4.8	1.5
PC-W01.30119	Tied On Card	12 / 48	3.8 / 4.8	1.5
PC-W01.32121	Tied On Card	12 / 48	7.1 / 8.6	2.72
PC-W01.32221	Tied On Card	12 / 48	8.6 / 9.6	2.77
PC-W01.32101	Tied On Card	12 / 48	7.6 / 8.6	2.72
PC-W01.32201	Tied On Card	12 / 48	5.1 / 6.6	2.92



PC-W01.32121
Plastic Impulse Sprinkler
 with Metal Spike with 3/4"
 Plastic Metal Adapter



PC-W01.32221
Plastic Impulse Sprinkler
 with Metal Spike and End Cap
 with 3/4" Plastic Metal Adapter



PC-W01.32101
Plastic Impulse Sprinkler
 with Plastic Spike with 3/4"
 Plastic Metal Adapter



PC-W01.32201
Plastic Impulse Sprinkler
 with Plastic Spike and End Cap
 with 3/4" Plastic Metal Adapter



PC-W01.30430
Male Impulse Sprinkler
 with 1/2" Male Thread (full circle)



PC-W01.30320
1/2" Male Impulse Sprinkler
 (full or part circle)



PC-W01.30144
1/2" Brass Impulse Sprinkler
 (full or part circle)

Item No.	Packing	Box / CTN	N.W. / G.W.	CUFT
PC-W01.30430	Tied On Card	12 / 48	11.2 / 12.2	1.78
PC-W01.30320	Tied On Card	12 / 48	12 / 13	1.6
PC-W01.30144	Tied On Card	12 / 48	12.5 / 14	1.5
PC-W01.32125	Tied On Card	12 / 48	16.1 / 17.1	2.52
PC-W01.32225	Tied On Card	12 / 48	16.8 / 18.3	2.52
PC-W01.32525	Tied On Card	12 / 48	25.4 / 26.9	2.18



PC-W01.32125
Metal Impulse Sprinkler
 with Metal Spike
 with 3/4" Plastic Male Adapter



PC-W01.32225
Metal Impulse Sprinkler
 with Metal Spike and End Cap
 with 3/4" Plastic Male Adapter



PC-W01.32525
Metal Impulse Sprinkler
 with Metal Step Spike and End Cap
 with 3/4" Plastic Male Adapter



PC-W04.11239E
**6 Pattern Gear Drive
 Sprinkler, Metal Spike**



PC-W04.12219E
**Quite Operation 2-Stage
 Gear Drive Sprinkler, Plastic
 Spike**

Item No.	Packing	Box/CTN	N.W./G.W.	CUFT	CBM
PC-W04.11239E	Tied On Card	12 / 48	15.6 / 16.1	3.37	0.095
PC-W04.12219E	Tied On Card	12 / 48	12.9 / 13.4	3.37	0.095
PC-W04.12227E	Tied On Card	4 / 24		4.22	0.119
PC-W04.12836E	Tied On Card	4 / 24		4.22	0.119



PC-W04.12227E
**Plastic Impulse Sprinkler,
 Plastic Spike**



PC-W04.12836E
**4 Pattern Gear Drive
 Sprinkler, Plastic Spike**



SHARE THE
JOY OF GARDENING



PC-W01.20300
1/2" Plastic Hose Quick
Connect Repair



PC-W01.20302
3/4" Plastic Hose Quick
Connect Repair



PC-W01.20301
1/2" Plastic Hose Quick
Connect Repair with Stop



PC-W01.20303
3/4" Plastic Hose Quick
Connect Repair with Sto

Item No.	Packing	Box / CTN	N.W. / G.W.	CUFT
PC-W01.20300	Blister On Card	50 / 200	7.9 / 8.9	2.3
PC-W01.20302	Blister On Card	50 / 200	9.5 / 10.5	2.8
PC-W01.20301	Blister On Card	50 / 200	8.1 / 9.1	2.3
PC-W01.20303	Blister On Card	50 / 200	10.2 / 11.2	2.8



PC-W01.20400
1/2" Plastic Hose Mender



PC-W01.20401
3/4" Plastic Hose Mender



PC-W01.20410
1/2"-3/4" Plastic Hose Mender



PC-W01.26503
2 Way Shut-off Valve
with 3/4"-1" Head



PC-W01.20600
2 Way Snap-in Coupling



PC-W01.25203
1" Plastic
Female Adapter



PC-W01.25202
3/4" Plastic
Female Adapter



PC-W01.36516
8 Pattern Sprinkler
with 3/4" Plastic Male Adapter



PC-W01.32020
Plastic Fan Sprinkler
with Plastic (Metal) Spike



PC-W01.32023
2-Way Hose Guide
and Metal Spike

Item No.	Packing	Box / CTN	N.W. / G.W.	CUFT
PC-W01.20400	Blister Card	50 / 200	5.1 / 6.1	1.75
PC-W01.20401	Sliding Card	50 / 200	9.3 / 10.3	2.7
PC-W01.20410	Sliding Card	50 / 200	9.3 / 10.3	2.7
PC-W01.26503	Tied On Card	5 / 60	6.5 / 8	1.71
PC-W01.20600	Blister Card	50 / 200	3.6 / 4.6	1.75
PC-W01.25203	Blister Card	50 / 200	4.1 / 5.1	2.6
PC-W01.25202	Blister Card	50 / 200	3.8 / 4.8	1.75
PC-W01.36516	Color Box	6 / 24	7.2 / 8.7	2.08
PC-W01.32020	Tied On Card	12 / 48	4.2 / 5.7	2.5
PC-W01.32023	Bulk	12 / 96	15.3 / 16.8	2.89



PC-W06.5814A
1/2" Connector with Stop



PC-W06.5814C
3/4" Connector with Stop



PC-W06.5815A
1/2" Qucik Connector



PC-W06.5815C
3/4" Qucik Connector



PC-W06.5818A
1/2" Hose Mendor



PC-W06.5818C
3/4" Hose Mendor



PC-W06.5816C
3/4" Tap Adaptor



PC-W06.5816D
1" Tap Adaptor

Item No.	Packing	Box/CTN	N.W./G.W.	CUFT	CBM
PC-W06.5814A	Tied On Card	20 / 200	8.9 / 10.9	1.80	0.051
PC-W06.5814C	Tied On Card	20 / 200	10.0 / 12.0	1.80	0.051
PC-W06.5815A	Tied On Card	20 / 200	8.7 / 10.7	2.20	0.062
PC-W06.5815C	Tied On Card	20 / 200	10.0 / 12.0	2.20	0.062

Item No.	Packing	Box/CTN	N.W./G.W.	CUFT	CBM
PC-W06.5818A	Tied On Card	20 / 200	5.4 / 7.4	1.80	0.051
PC-W06.5818C	Tied On Card	20 / 200	11.6 / 13.6	2.20	0.062
PC-W06.5816C	Tied On Card	20 / 200	2.9 / 4.9	1.90	0.054
PC-W06.5816D	Tied On Card	20 / 200	4.2 / 6.2	2.20	0.062



PC-W06.5811
5" Twist Nozzle



PC-W06.5830
1/2"-3/4" Tap Adaptor



PC-W06.5831
3/4"-1" Tap Adaptor



PC-W06.5835
3-Way Coupler



PC-W06.5006
4-Way Tap with Swivel Head



PC-W06.5009
2-Way Tap with Swivel Head

Item No.	Packing	Box/CTN	N.W./G.W.	CUFT	CBM
PC-W06.5811	Tied On Card	20 / 200	12.7 / 14.7	2.80	0.079
PC-W06.5830	Tied On Card	20 / 200	4.2 / 6.2	1.85	0.052
PC-W06.5831	Tied On Card	20 / 200	4.0 / 8.8	2.50	0.071
PC-W06.5835	Tied On Card	20 / 200	3.5 / 5.5	1.30	0.037
PC-W06.5006	Tied On Card	10 / 60	16.1 / 17.3	2.20	0.062
PC-W06.5009	Tied On Card	10 / 100	14.9 / 16.1	2.00	0.057



PC-W04.22000
Angled Quick Adaptor



PC-W04.24133
Quick Connector with
Manual Valve



PC-W04.22240
Multi-Function Tap Adaptor



PC-W04.22254
Multi-Function Tap Manifold
with Twin Hose Connectors



PC-W04.22138
3/4" Inline Water Filter

Item No.	Packing	Box/CTN	N.W./G.W.	CUFT	CBM
PC-W04.22000	Tied On Card	10 / 100	8.5 / 9.0	1.96	0.056
PC-W04.24133	Tied On Card	10 / 40		1.15	0.033
PC-W04.22240	Tied On Card	12 / 48	8.2 / 8.7	1.76	0.050
PC-W04.22254	Tied On Card	10 / 60	13.2 / 14.7	2.05	0.058
PC-W04.22138	Tied On Card	10 / 40	4.0 / 4.5	1.15	0.033

OSCILLATING SPRINKLER



PC-W04.17147E
Variable-Width Oscillating
Sprinkler



PC-W04.17173-003E
Compact Oscillating
Sprinkler



PC-W04.17174-002E
Oscillating Sprinkler



PC-W03.POS500A-1
15 Hole Oscillating Sprinkler



PC-W03.POS700-1
15 Hole Oscillating Sprinkler

Item No.	Packing	Box/CTN	N.W./G.W.	CUFT	CBM
PC-W04.17147E	Color Box	6	4.4 / 5.2	1.75	0.050
PC-W04.17173-003E	Color Box	6	2.35 / 2.9	1.00	0.028
PC-W04.17174-002E	Color Box	6	3.25 / 4.05	1.7	0.048
PC-W03.POS500A-1	Header Card	6 / 24	7.6 / 10.3	3.70	-
PC-W03.POS700-1	Header Card	6 / 24	6.8 / 9.4	3.90	-

Pecker

6 PATTERN WATER WAND

28"
710mm

Beautiful Garden
Wonderful Life



PC-73316

6 PATTERN WATER WAND

Front-pull flow-control plastic handle
With 3/4" plastic male adapter



180°
Angle Adjustable
Spray Head

- SHOWER
- FLAT
- VERTICAL
- MIST
- CONE
- JET

WARNING
Always wear proper eye protection; blades are sharp, handle with care



www.pecker-garden.com.tw

Pecker

6 PATTERN WATER WAND



Beautiful
Won

Recker

8" 205mm

BYPASS PRUNING SHEARS

Beautiful Garden Wonderful Life

PC-768N

Recker

28" 710mm

TRANSPLANTER

Beautiful Garden Wonderful Life

PC-151B

28" 710mm

Beautiful Garden Wonderful Life

PC-73316

6 PATTERN WATER WAND

Front-pull flow-control plastic handle
With 3/4" plastic male adapter

180°
Angle Adjustable
Spray Head

SHOWER FLAT VERTICAL
MIST CONE JET

WARNING
Always wear proper eye
protection; blades are
sharp. handle with care

www.pecker-garden.com.tw

Recker

8" 205mm

BYPASS PRUNING SHEARS

Beautiful Garden Wonderful Life

PC-768N

TRANSPLANTER

WE TAKE CARE OF THE CREATION TOGETHER

Pecker is the ideal brand in gardening.
Making the best garden tools continually is our mission.
Thank you for your support.



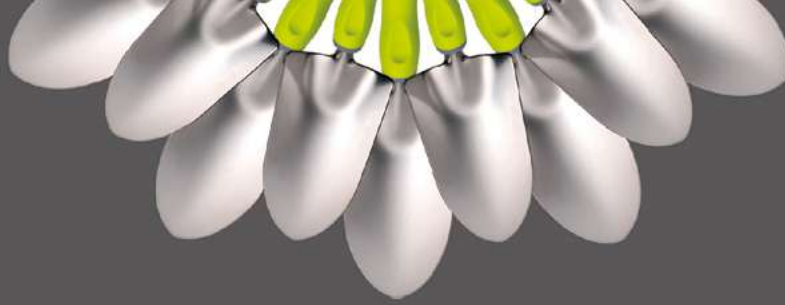

BEAUTIFUL
GARDEN
WONDERFUL
LIFE



Managing Director
Julian Chu



FORMOSA CREATE TOOLS CO., LTD.

No.15, Jingxian 3rd Rd., Beitun District.,
Taichung City 40642, Taiwan

T 886-4-2437-9255 / F 886-4-2437-9256

E fordir@so-net.net.tw

W www.pecker-garden.com.tw